



ICOM

**SERVICE
MANUAL**

IC-751A

ICOM INCORPORATED

SECTION 6 MAINTENANCE AND ADJUSTMENT

6 - 1 PREPARATION BEFORE SERVICING

1. Detach the power cord and turn **OFF** the VOLUME/POWER CONTROL before performing any work on the transceiver.
2. Do not short circuit components while making adjustments.
3. Use an insulated tuning tool for all adjustments.
4. Do not force any of the variable components. Turn them slowly and smoothly.
5. Follow the instructions exactly. If an indicated result is not obtained, repeat the instruction until the correct result is obtained.
6. Check the condition of connectors, solder joints and screws when adjustments are complete. Confirm that components do not touch each other.
7. Confirm defective operation of the transceiver first when checking an out-of-service unit. Verify that external sources do not cause the problem.
8. Use the correct tools and test equipment.
9. Remove the transceiver case as shown in SECTION 5-1.
10. Attach a 13.8V DC external power source to the power supply connector. Be sure to check the polarity.
11. For transmission problems, attach a dummy load to the antenna connector. For reception problems, attach an antenna or signal generator to the antenna connector. **DO NOT transmit** into the signal generator.
12. Recheck for the suspected malfunction with the VOLUME/POWER CONTROL **ON**.
13. Check the defective circuit. Measure the DC voltages of the collector, base and emitter of each transistor.

6-2 PLL ADJUSTMENT

TEST INSTRUMENTS REQUIRED		MEASUREMENT CONNECTION LOCATION				
(1) AC POWER SUPPLY • Output voltage : 13.8V DC • Current capacity : 20A or more (2) OSCILLOSCOPE • Frequency range : DC ~ 20MHz • Measuring range : 0.01 ~ 10V (3) FREQUENCY COUNTER • Frequency range : 0.1 ~ 90MHz • Frequency accuracy : ± 1 ppm or better • Sensitivity : 100mV or better (4) RF VOLTMETER • Frequency range : 0.1 ~ 80MHz • Measuring range : 0.01 ~ 10V						
ADJUSTMENT	ADJUSTMENT CONDITIONS	MEASUREMENT		VALUE	ADJUSTMENT POINT	
		UNIT	LOCATION		UNIT	ADJUST
CALIBRATOR	1 • Frequency display: 8.0000MHz • LSB General mode	PLL	Connect an oscilloscope to J1 pin 6 6	3V	TOP PANEL	CALIBRATOR CONTROL
REFERENCE FREQUENCY	1 • Frequency display: 8.0000MHz • LSB General mode	PLL	* Connect a frequency counter to R7 (R2 side).	30.7200MHz	PLL	L2
PLL LO OUTPUT LEVEL	1 • Frequency display: 8.0000MHz • LSB General mode	PLL	Connect an RF Voltmeter to L13.	Adjust to maximum output: 400mV ~ 1Vp-p	PLL	L8
LOCK VOLTAGE	1 • Frequency display: 8.0000MHz • LSB General mode	PLL	Connect an oscilloscope to R202.	3V	PLL	L201
	2 • Frequency display: 7.9999MHz			1.5 ~ 2V		
HPL LOCK VOLTAGE	1 • Frequency display: 7.9999MHz • LSB General mode	PLL	Connect an oscilloscope to R46.	6.5V	PLL	C78
	2 • Frequency display: 14.9999MHz • LSB General mode			C88		
	3 • Frequency display: 21.9999MHz			C97		
	4 • Frequency display: 29.9999MHz			C107		
	5 • Frequency display: 8.0000MHz			L201		
	6 • Frequency display: 15.0000MHz					
	7 • Frequency display: 22.0000MHz					
	8 • Frequency display: 7.9999MHz • LSB General mode			2.5V		R43
2nd LO OUTPUT LEVEL	1 • Frequency display: 8.0000MHz • LSB General mode	PLL	Terminate J5 to ground with a 50Ω resistor. Connect an RF Voltmeter to J5.	Adjust to maximum output: 250 ~ 400mV rms	PLL	L3 ~ L5
NOTE: After completing the adjustment, return J5 to its original condition.						

* PUT 470Ω IN SERIES WITH MORE.

OR UNPLUG P2 FROM J5 CONNECT COUNTER TO J5

AD L2 FOR 61.44 MHz

PLL UNIT

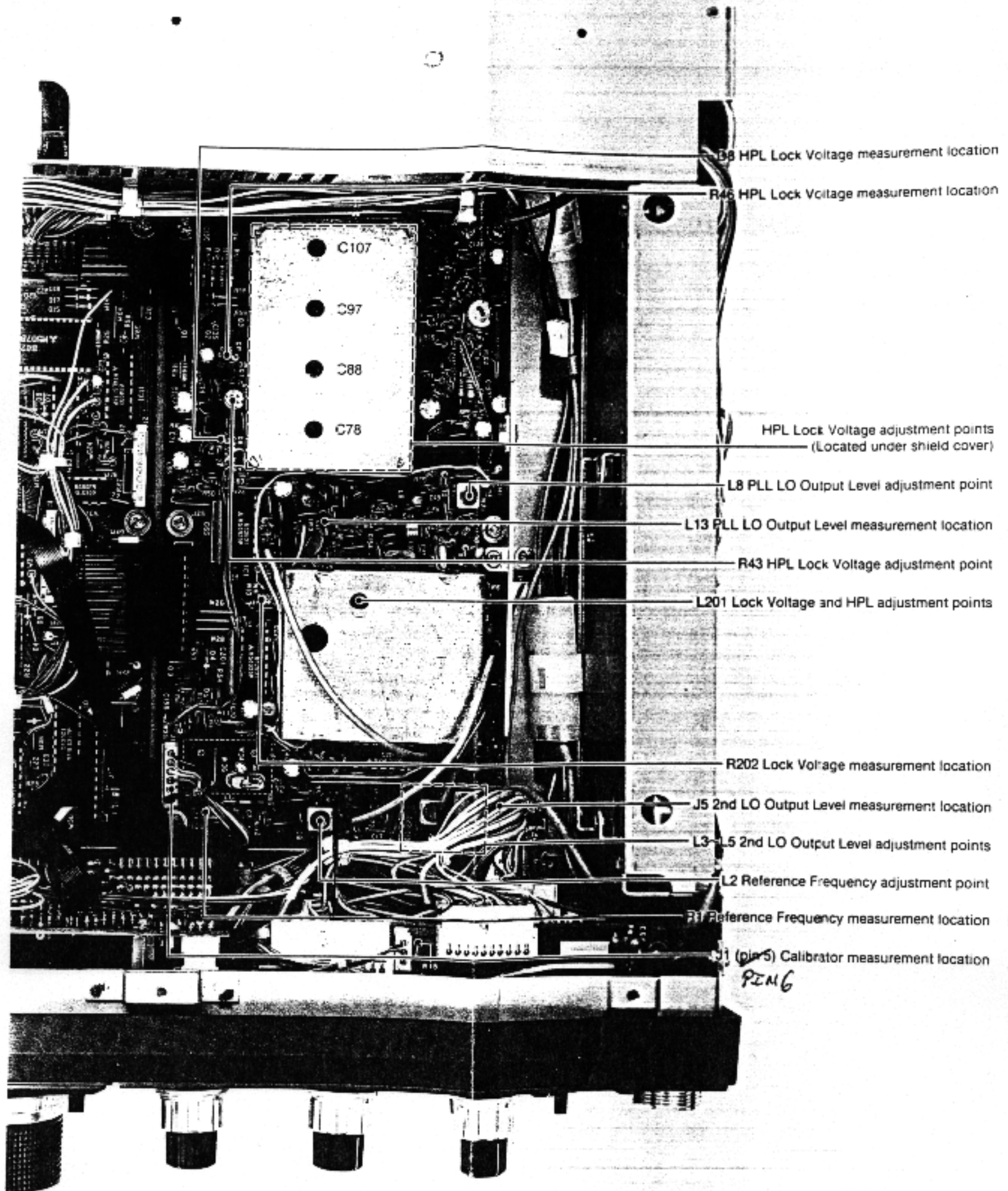

B8 HPL Lock Voltage measurement location

R46 HPL Lock Voltage measurement location

C107

C97

C88

C78

HPL Lock Voltage adjustment points
(Located under shield cover)

L8 PLL LO Output Level adjustment point

L13 PLL LO Output Level measurement location

R43 HPL Lock Voltage adjustment point

L201 Lock Voltage and HPL adjustment points

R202 Lock Voltage measurement location

J5 2nd LO Output Level measurement location

L3-L5 2nd LO Output Level adjustment points

L2 Reference Frequency adjustment point

R1 Reference Frequency measurement location

J1 (pin 5) Calibrator measurement location

P216

R7

6 - 3 FREQUENCY ADJUSTMENT

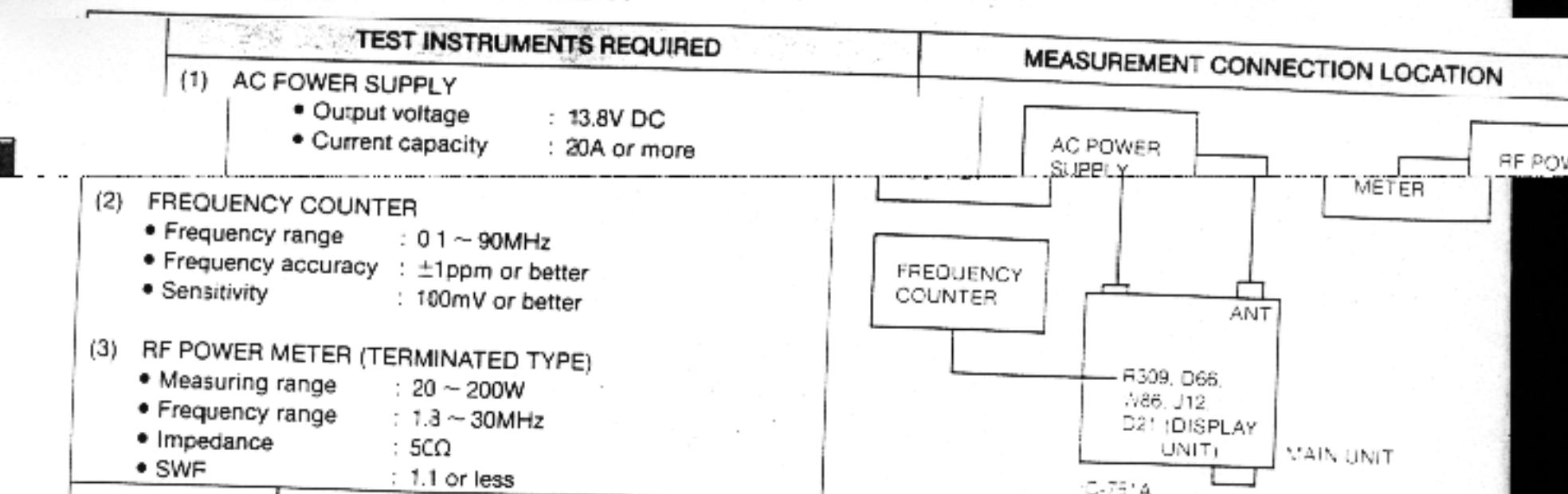

ADJUSTMENT	ADJUSTMENT CONDITIONS	MEASUREMENT			ADJUSTMENT POINT			
		UNIT	LOCATION	VALUE	UNIT	ADJUST		
BFO FREQUENCY	1	MAIN	Connect a frequency counter to R309 (X6 side).	9.01300MHz	MAIN	C202		
	2			9.01000MHz			Verify	
	3			9.00990MHz				
	4			9.008475MHz				
	5			No output				
	6			9.01000MHz				
	7			9.01000MHz				L29
	8			9.01060MHz				C20
	9			9.01077MHz				C17
	10			9.01145MHz				C15
	11			Verify				
PBT FREQUENCY	1	MAIN	Connect a frequency counter to W86.	9.46650MHz	MAIN	L36		
	2			9.46800MHz or higher			Verify	
	3			9.46500MHz or lower				
	4			9.43650MHz				R337
CW SIDETONE	1	MAIN	Connect a frequency counter to pin 3 on J12.	700Hz	MAIN	R374		
DC-DC CONVERTER FREQUENCY	1	DISPLAY	Connect a frequency counter to the cathode of D21. (Location on p.7-3)	approx. 20kHz		Verify		

S2
S1
S1
S2
S1

NOTE: Repeat adjustments 6 through 10 several times.

NOTE: Return J4 to its original condition after completing Adjustment 8.

Turn R196 fully CW and set the transceiver in receive mode.

MAIN UNIT

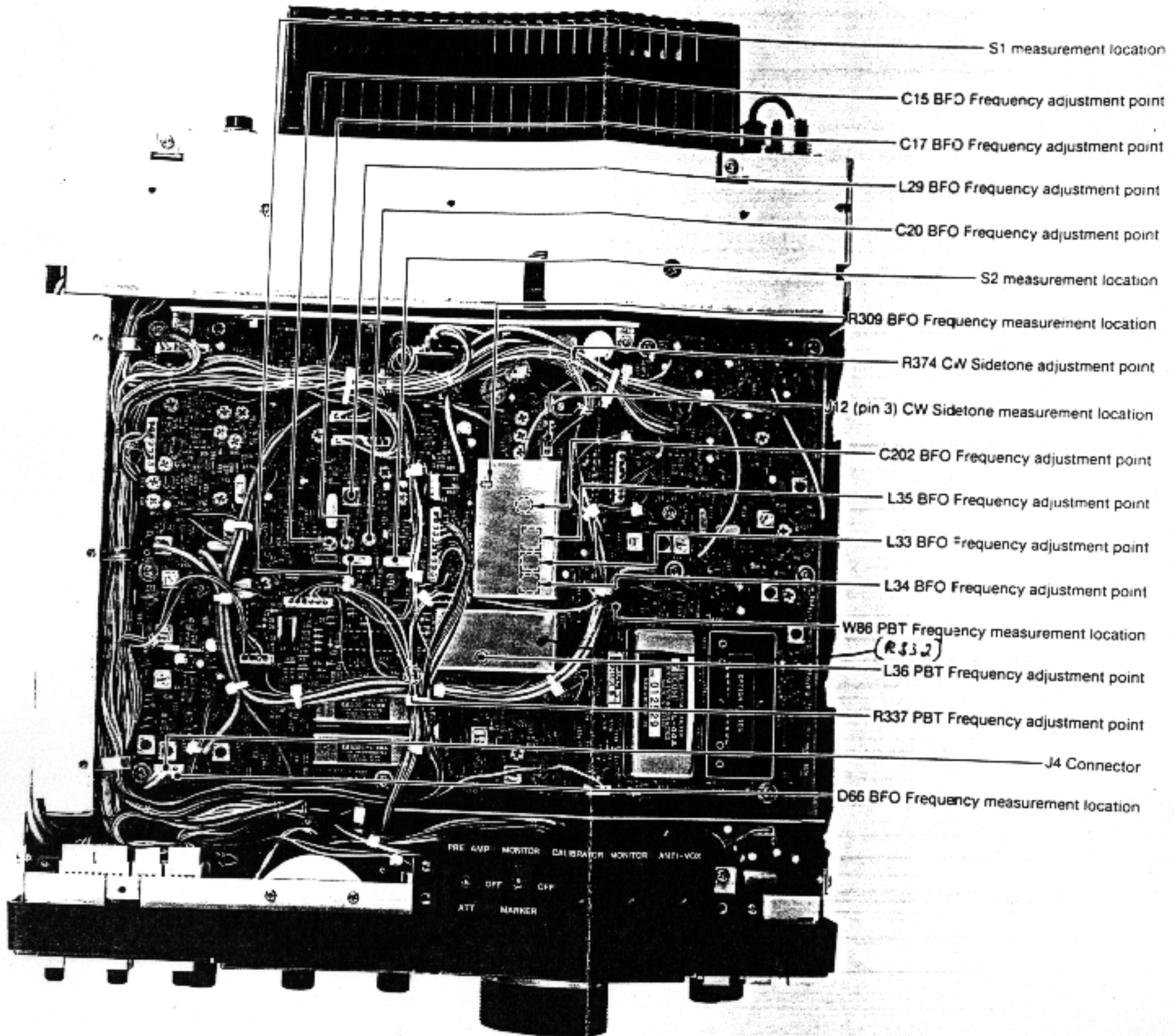

6 - 4 RECEIVER ADJUSTMENT

TEST INSTRUMENTS REQUIRED		MEASUREMENT CONNECTION LOCATION						
(1) AC POWER SUPPLY • Output voltage : 13.8V DC • Current capacity : 2CA or more (2) STANDARD SIGNAL GENERATOR (SSG) • Frequency range : 0.1 ~ 40MHz • Output level : -127 ~ -17dBm (0.1 μ V~32mV) (3) AC MILLI-VOLTMETER • Measuring range : 10mV ~ 3V (4) EXTERNAL SPEAKER • Impedance : 8 Ω (5) OSCILLOSCOPE • Frequency range : DC ~ 20MHz • Measuring range : 0.01 ~ 10V								
ADJUSTMENT	ADJUSTMENT CONDITIONS	MEASUREMENT		VALUE	ADJUSTMENT POINT			
		UNIT	LOCATION		UNIT	ADJUST		
TOTAL GAIN	1	REAR PANEL	Connect an AC milli-voltmeter to the EXT. SP JACK.	Adjust to MAX. AF output.	MAIN	L10, L11, L12, L18, L22, L25, L26		
	2					Adjust the AF GAIN CONTROL until 2.5V is output.	FRONT PANEL	AF GAIN CONTROL
	3					Adjust R259 to a point where the noise level is 30dB (about 80mV) from 2.5V.	MAIN	R259
S-METER	1	FRONT PANEL	Multifunction meter (S scale)	S0 (S scale)	MAIN	R125		
	2					Multifunction meter (S scale)	S9 (S scale)	R442
	3					Multifunction meter (S scale)	S9 +60dB (S scale)	R121

MAIN UNIT

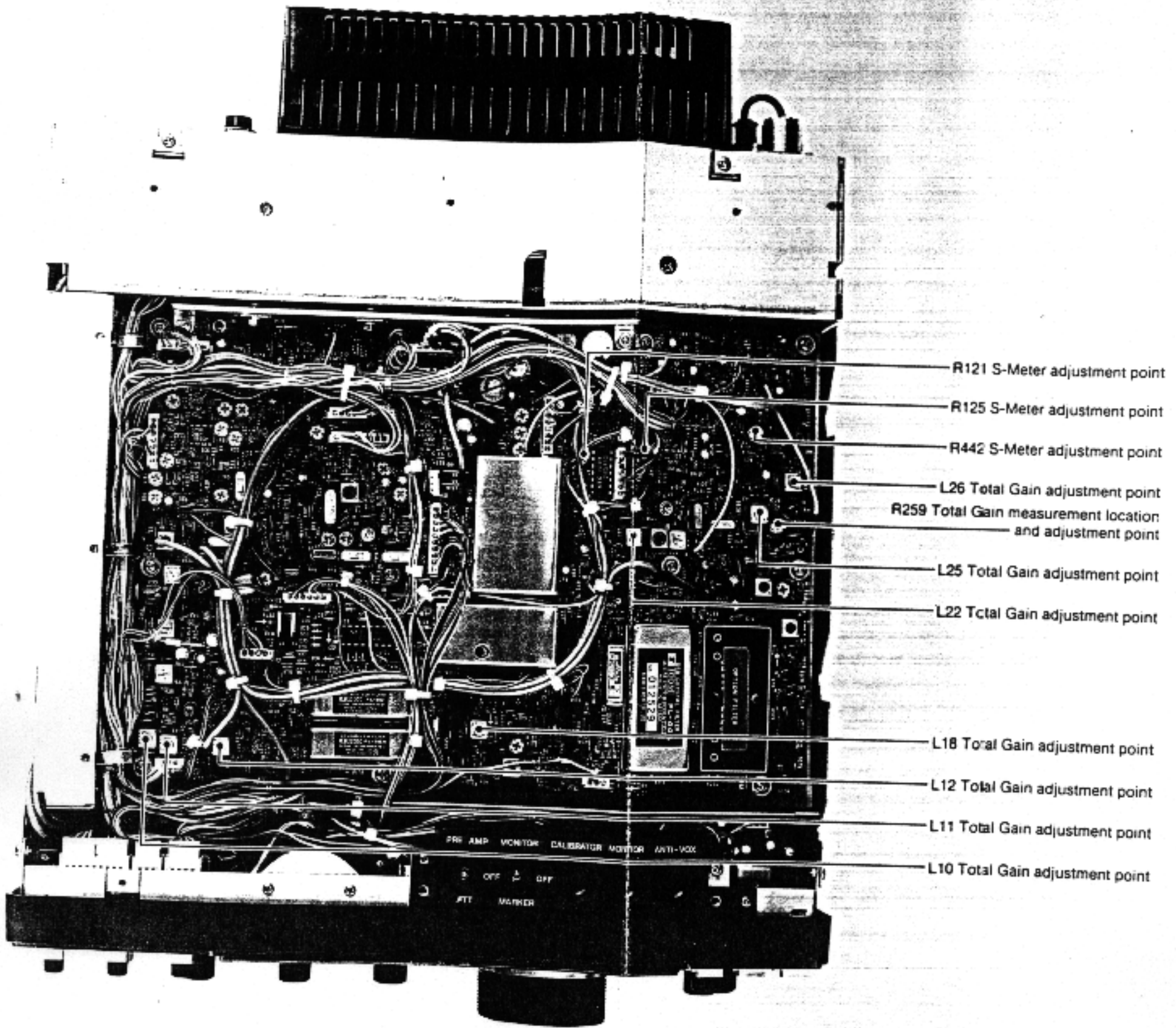

R121 S-Meter adjustment point

R125 S-Meter adjustment point

R442 S-Meter adjustment point

L26 Total Gain adjustment point

R259 Total Gain measurement location
and adjustment point

L25 Total Gain adjustment point

L22 Total Gain adjustment point

L18 Total Gain adjustment point

L12 Total Gain adjustment point

L11 Total Gain adjustment point

L10 Total Gain adjustment point

PRE AMP MONITOR CALIBRATOR MONITOR ANTI-VOX

OFF OFF

ATT METER

RECEIVER ADJUSTMENT

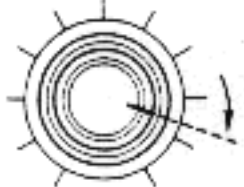
ADJUSTMENT	ADJUSTMENT CONDITIONS	MEASUREMENT		VALUE	ADJUSTMENT POINT								
		UNIT	LOCATION		UNIT	ADJUST							
S-METER	4 <ul style="list-style-type: none"> Apply a -33dBm (5mV) RF signal to the ANTENNA CONNECTOR. PRE AMP SWITCH: ON ATT SWITCH: ON 	FRONT PANEL		Record the reading.									
				A position 10dB up on the S-Meter		Verify							
				A position 20dB down on the S-Meter									
NOISE BLANKER	1 <ul style="list-style-type: none"> Frequency display: 14MHz USB mode PRE AMP SWITCH: OFF NB WIDE SWITCH: ON NB LEVEL CONTROL: MAX. CW Apply pulse-type noise to the ANTENNA CONNECTOR. 	MAIN	Connect an oscilloscope to D18	Adjust to MAX. waveform on the oscilloscope.	MAIN	L4 - L6							
							NOTE: The noise blanker will not function for wide noises (pulse width approx. 5m secs.) when the NB WIDE SWITCH is turned OFF. The noise blanker will function when receiving narrow noises (pulse width approx. 0.4 ~ 0.5m secs.) regardless of the position of the NB WIDE SWITCH.						
NOTCH	1 <ul style="list-style-type: none"> Frequency display: 14.1485MHz MARKER SWITCH: ON NOTCH SWITCH: ON NOTCH CONTROL: MAX. CW and CCW. 	FRONT PANEL		S-Meter remains at the same level when the NOTCH CONTROL is turned fully CW or CCW.	MAIN	L24							
							2 <ul style="list-style-type: none"> NOTCH SWITCH: OFF 	REAR PANEL	Connect an AC millivoltmeter to the EXT. SP JACK.	2.5V	FRONT PANEL	AF GAIN CONTROL	
										<ul style="list-style-type: none"> NOTCH SWITCH: ON 	Less than 150mV	FRONT PANEL	NOTCH CONTROL
							NOTE: Repeat steps 2 and 3 (below) two or three times.						
							3	<ul style="list-style-type: none"> Frequency display: 14.1472MHz NOTCH SWITCH: ON NOTCH CONTROL: MAX. CCW 	REAR PANEL	Connect an AC millivoltmeter to the EXT. SP JACK.	MIN. audio output	MAIN	L23
4	<ul style="list-style-type: none"> Frequency display: 14.1498MHz 	Connect an AC millivoltmeter to the EXT. SP JACK.	MIN. level	FRONT PANEL	NOTCH CONTROL								
NOTE: Verify the NOTCH CONTROL position as shown below.													
PBT  NOTCH													

MAIN UNIT

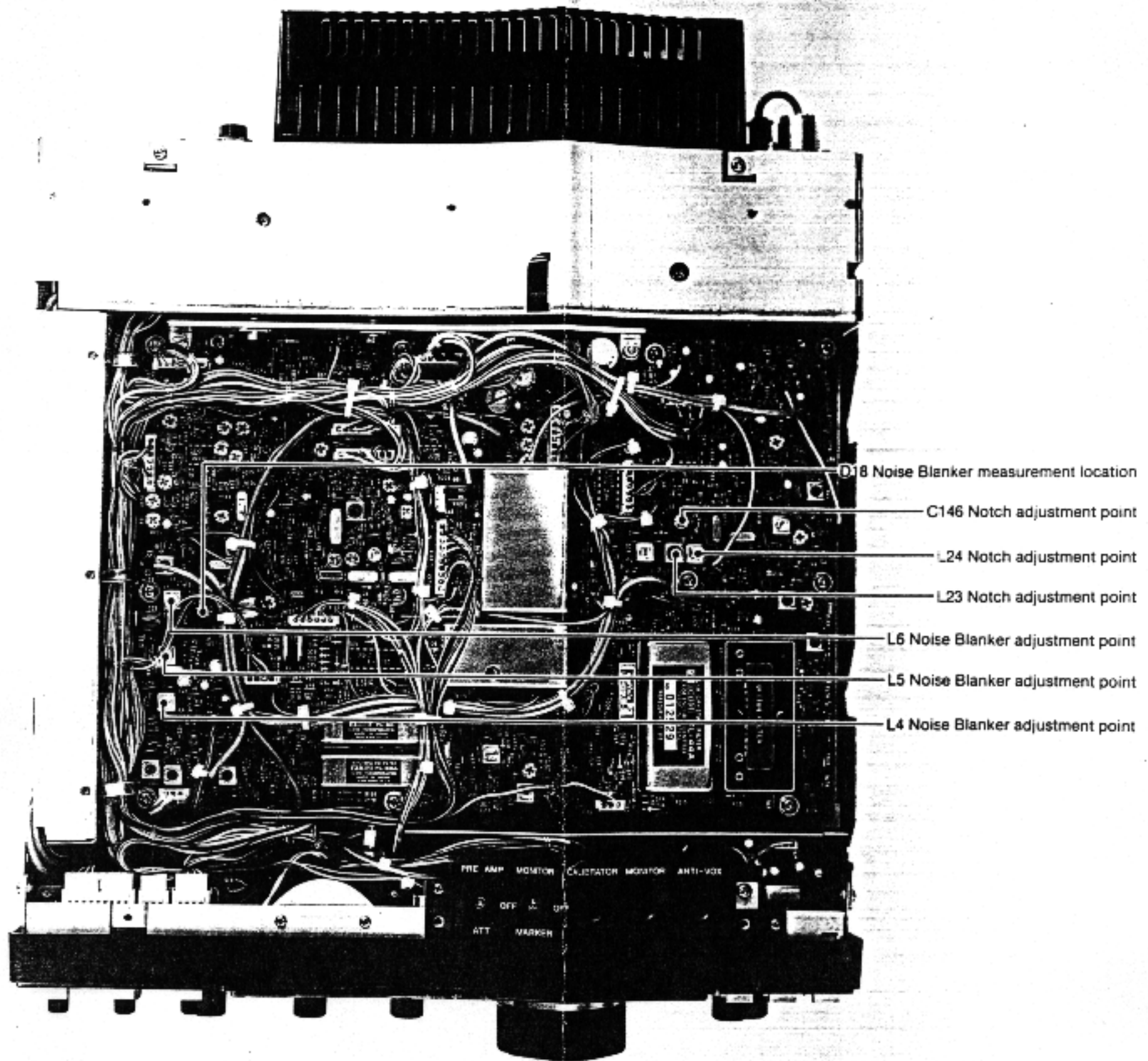

- D18 Noise Blanker measurement location
- C146 Notch adjustment point
- L24 Notch adjustment point
- L23 Notch adjustment point
- L6 Noise Blanker adjustment point
- L5 Noise Blanker adjustment point
- L4 Noise Blanker adjustment point

6 - 5 TRANSMITTER ADJUSTMENT

TEST INSTRUMENTS REQUIRED		MEASUREMENT CONNECTION LOCATION	
(1) AC POWER SUPPLY	<ul style="list-style-type: none"> Output voltage : 13.8V DC Current capacity : 25A or more 		
(2) RF POWER METER (TERMINATED TYPE)	<ul style="list-style-type: none"> Measuring range : 20 ~ 200W Frequency range : 1.8 ~ 30MHz Impedance : 50Ω SWR : 1.1 		
(3) AF GENERATOR (AG)	<ul style="list-style-type: none"> Frequency range : 200 ~ 3000Hz Output level : 0 ~ 300mV 		
(4) AC MILLI-VOLTMETER	<ul style="list-style-type: none"> Measuring range : 10mV ~ 3V 		
(5) RF VOLTMETER	<ul style="list-style-type: none"> Frequency range : 0.1 ~ 80MHz Measuring range : 0.01 ~ 10V 		
(6) OSCILLOSCOPE	<ul style="list-style-type: none"> Frequency range : DC ~ 20MHz Measuring range : 0.01 ~ 10V 		
(7) AMMETER	<ul style="list-style-type: none"> Measurement capability to : 1A and 25A 		
(8) FM DEVIATION METER	<ul style="list-style-type: none"> Frequency minimum : 30MHz Measuring range : 0 ~ ±5kHz De-emphasis : OFF 		

ADJUSTMENT	ADJUSTMENT CONDITIONS	MEASUREMENT		VALUE	ADJUSTMENT POINT	
		UNIT	LOCATION		UNIT	ADJUST
BIAS VOLTAGE Ⓐ For driver transistors	<ul style="list-style-type: none"> Frequency display: 14MHz SSB mode MIC GAIN CONTROL: Turn fully CCW After confirming there is no MIC input, set the transceiver in transmit mode. <p>NOTE: Resolder after making adjustments in steps 1 and 2.</p>	PA	Desolder the center of W35. 	100mA	PA	R27
Ⓑ For final transistors			Desolder R20 and connect an ammeter between W10 and R20. 	500mA		R23

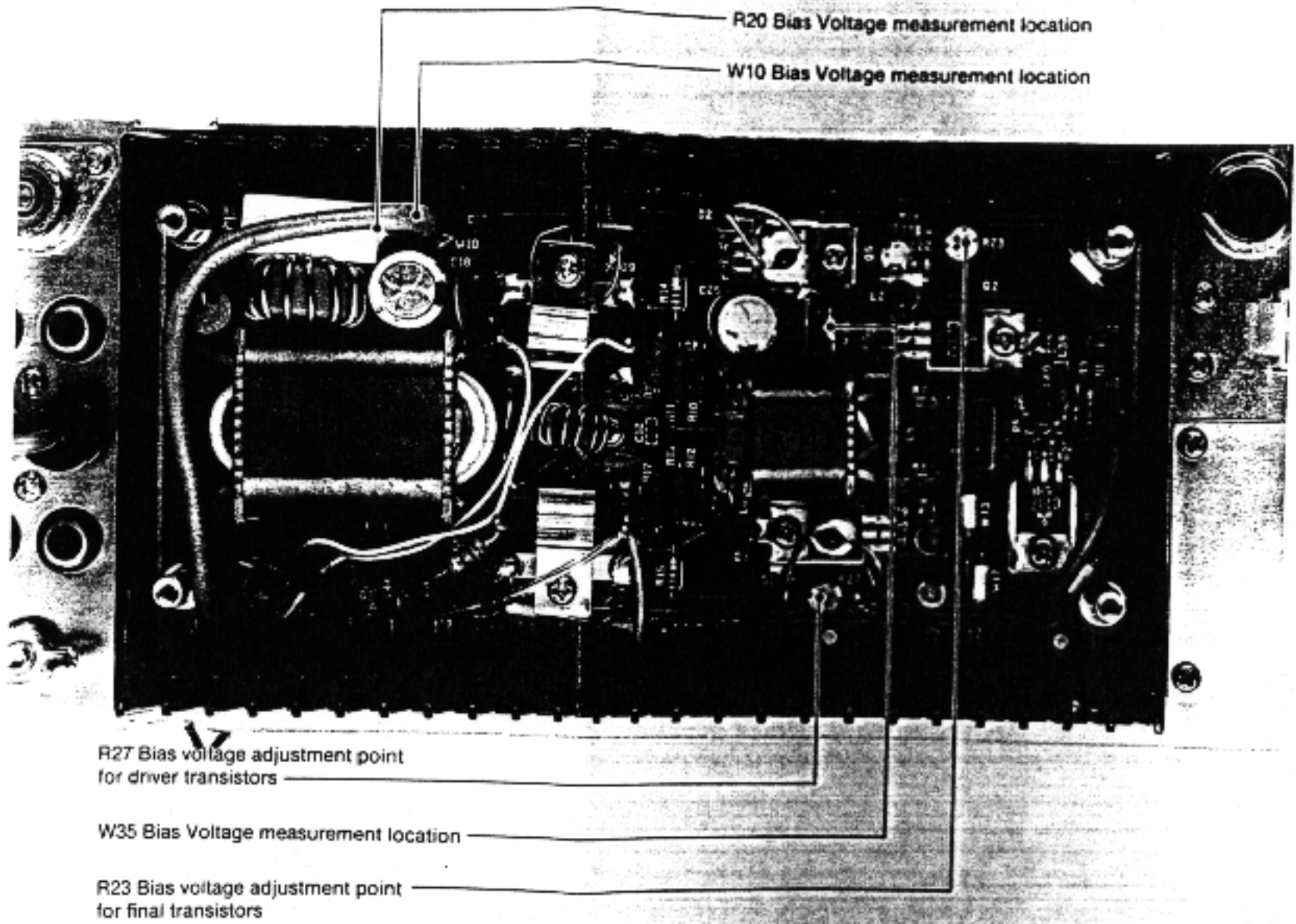

TRANSMITTER ADJUSTMENT

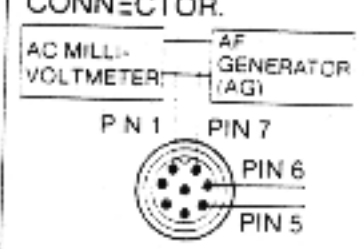
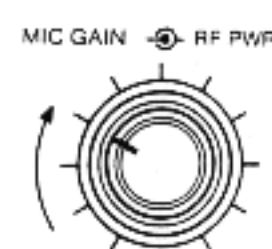
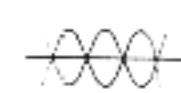
CONDITIONS	MEASUREMENT	ADJUSTMENT POINT	UNIT	LOCATION	VALUE	ADJUSTMENT UNIT	ADJUSTMENT POINT	
OUTPUT POWER	1	<ul style="list-style-type: none"> Frequency display: 14MHz USB mode COMP SWITCH: OFF Apply a 1.5kHz/3mV signal from the AG, then adjust the MIC GAIN CONTROL to output 30W of power. 	REAR PANEL	Connect an RF power meter to the ANTENNA CONNECTOR. 	Adjust to obtain MAX. output power.	MAIN	L1	
	2	<ul style="list-style-type: none"> FM mode MIC GAIN CONTROL: MAX. CCW MIC GAIN CONTROL: MAX. CW Note: The RF POWER CONTROL should remain in the same position as in step 2 above.			50W FRONT PANEL RF POWER CONTROL MAX. output MAIN L2			
Ic • APC	1	<ul style="list-style-type: none"> Frequency display: 14MHz RTTY mode RF POWER CONTROL: MAX. CW Transmit mode 	REAR PANEL	Connect an ammeter to the power cable.	22A	MAIN	R99	
ALC	1	<ul style="list-style-type: none"> Frequency display: 14MHz RTTY mode RF POWER CONTROL: MAX. CW 	REAR PANEL	Connect an RF power meter to the ANTENNA CONNECTOR.	100W	MAIN	R87	
	2	<ul style="list-style-type: none"> RF POWER CONTROL: MAX. CCW 			3~10W		Verify	
	NOTE: Check that the RF output power on each band is 90 ~ 100W and that the current drain is less than 20A.							
	3	<ul style="list-style-type: none"> RF POWER CONTROL: MAX. CW S8 on MAIN UNIT: Switch to rear panel side. Transmit mode 	REAR PANEL	Connect an RF power meter to the ANTENNA CONNECTOR.	50W	MAIN	R84	
	4	<ul style="list-style-type: none"> RF POWER CONTROL: MAX. CW AM mode MIC GAIN CONTROL: (set as shown) 		Connect an oscilloscope to the ANTENNA CONNECTOR. 100% modulation  or 50W RF output power.			R159	
5	<ul style="list-style-type: none"> MIC GAIN CONTROL: MAX. CCW 		Connect an RF power meter to the ANTENNA CONNECTOR.	40~60W		Verify		
CARRIER SUPPRESSION	1	<ul style="list-style-type: none"> Frequency display: 14MHz USB and LSB modes COMP SWITCH: OFF MIC GAIN CONTROL: MAX. CCW Transmit mode 	REAR PANEL	Connect an RF voltmeter or spectrum analyzer to the ANTENNA CONNECTOR.	Alternately change the operating mode between USB and LSB, and adjust R158 and R161 for MIN. output of less than -50dB.	MAIN	R158 R161	
	2	<ul style="list-style-type: none"> COMP SWITCH: ON 			Less than -50dB		Verify	

MAIN UNIT

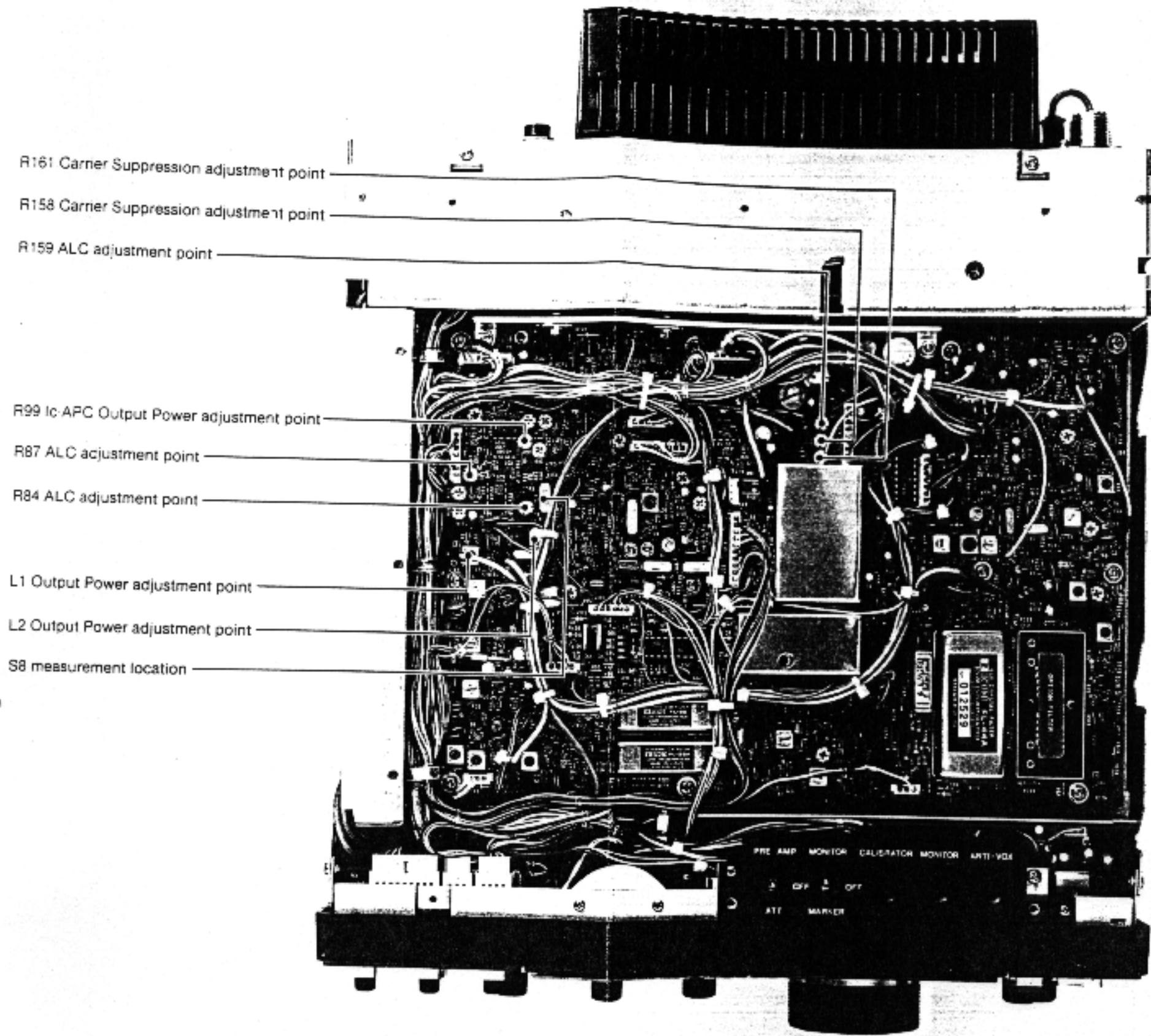

R161 Carrier Suppression adjustment point

R158 Carrier Suppression adjustment point

R159 ALC adjustment point

R99 APC Output Power adjustment point

R87 ALC adjustment point

R84 ALC adjustment point

L1 Output Power adjustment point

L2 Output Power adjustment point

S8 measurement location

TRANSMITTER ADJUSTMENT

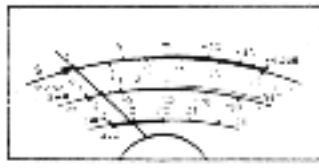
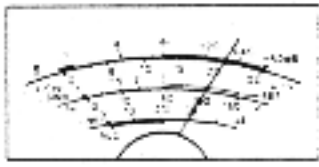
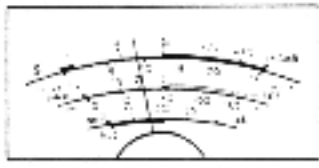
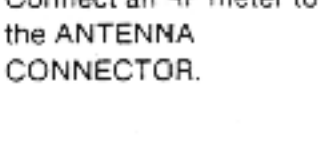
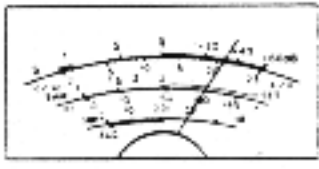
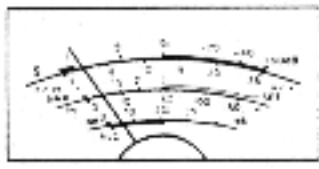
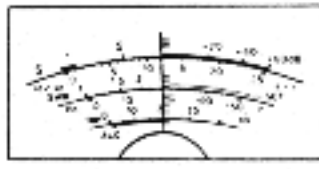
ADJUSTMENT	ADJUSTMENT CONDITIONS	MEASUREMENT		VALUE	ADJUSTMENT POINT			
		UNIT	LOCATION		UNIT	ADJUST		
METER Ⓐ I _c METER	1	REAR PANEL	Connect an ammeter to the power cable.	Adjust to total current minus 3A.	MAIN	R98		
	2					<ul style="list-style-type: none"> HAM/GENE SWITCH: GENE  <p>Multifunction meter (I_c scale)</p>	1A (I _c scale)	R103
Ⓑ COMP METER	3	FRONT PANEL	<ul style="list-style-type: none"> USB mode COMP SWITCH: ON METER SWITCH: COMP Input 2 audio signals into the MIC CONNECTOR: 1.9kHz 3mV 1.3kHz 3mV 	 <p>Multifunction meter (COMP scale)</p>	25dB (COMP scale)	FRONT PANEL	MIC GAIN CONTROL	
							<ul style="list-style-type: none"> METER SWITCH: ALC  <p>Multifunction meter (I_c scale)</p>	9A (I _c scale)
	4	REAR PANEL	Connect an RF meter to the ANTENNA CONNECTOR.	<ul style="list-style-type: none"> COMP SWITCH: OFF METER SWITCH: COMP Input an audio signal into the MIC CONNECTOR: 1.5kHz 3mV 	 <p>Multifunction meter (I_c scale)</p>	3CW	FRONT PANEL	MIC GAIN CONTROL
								<ul style="list-style-type: none"> COMP SWITCH: ON
Ⓒ P _o METER	5	FRONT PANEL	Connect an RF meter to the ANTENNA CONNECTOR.	 <p>Multifunction meter (P_o scale)</p>	100W	MAIN	RF POWER CONTROL	
							<ul style="list-style-type: none"> RTTY mode COMP SWITCH: OFF METER SWITCH: P_o Transmit mode 	100% (P _o scale)
Ⓓ ALC METER	6	FRONT PANEL	<ul style="list-style-type: none"> USB mode METER SWITCH: ALC Apply an AF signal to the MIC CONNECTOR: 1.5kHz 3mV 	 <p>Multifunction meter (I_c scale)</p>	2A (I _c scale)	FRONT PANEL	MIC GAIN CONTROL	
							<ul style="list-style-type: none"> Apply an AF signal to the MIC CONNECTOR: 1.5kHz 9.4mV (10dB up)  <p>Multifunction meter (ALC scale)</p>	Full scale in the ALC zone

MAIN UNIT

R103 Ic Meter adjustment point

R98 Ic Meter adjustment point

R68 Pa Meter adjustment point

R91 Pa Meter adjustment point

R196 COMP Meter adjustment point

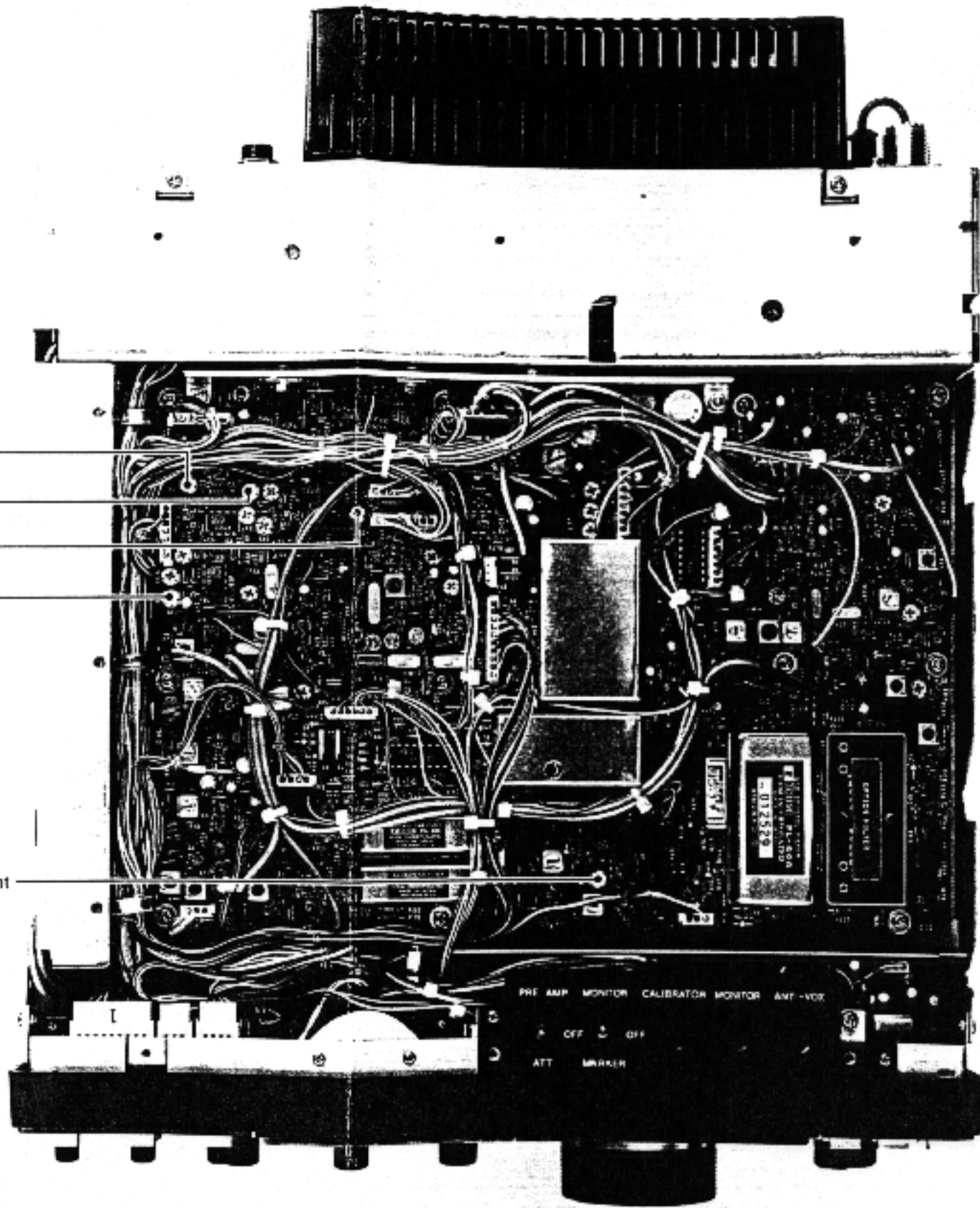

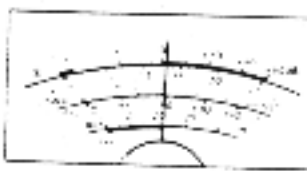
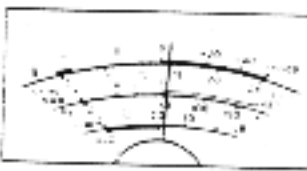
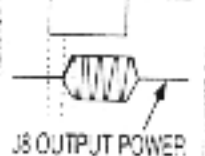
ADJUSTMENT	MEASUREMENT	ADJUSTMENT CONDITIONS	MEASUREMENT			ADJUSTMENT POINT					
			UNIT	LOCATION	VALUE	UNIT	ADJUST				
③ SWR METER	6	<ul style="list-style-type: none"> • Frequency display: 14MHz • RTTY mode • METER SWITCH: Po • Transmit mode 	FRONT PANEL	Po METER		Adjust RF POWER CONTROL until the meter needle is at "SWR SET".	FRONT PANEL	RF POWER CONTROL			
				Multifunction meter (SWR scale)					Adjust to MIN. SWR (less than 1.2).	FILTER	C36
				SWR METER							
				SWR METER							
③ Vc METER	9	<ul style="list-style-type: none"> • SSB mode • MIC GAIN CONTROL: fully CCW • METER SWITCH: Vc • No MIC input • Transmit mode 	FRONT PANEL		Vc METER	13.8V	MAIN	R106			
									Multifunction meter (Vc scale)		
③ SWR APC	10	<ul style="list-style-type: none"> • RTTY mode • RF POWER CONTROL: MAX. • Remove any connection to the ANTENNA CONNECTOR 	REAR PANEL	Connect an ammeter between the AC POWER SUPPLY and the transceiver.		Less than 12A		Verify			
TRANSMIT START TIME	1	<ul style="list-style-type: none"> • CW mode • VOX SWITCH: ON • KEYSPEED CONTROL: MAX. CW • VOX DELAY CONTROL: MAX. CCW • Key down to dot position 	MAIN	Connect lead of an oscilloscope to the cathode of D13.		19ms	MAIN	R451			
			RF	Connect other lead of an oscilloscope to J8.							
FM DEVIATION		<ul style="list-style-type: none"> • Frequency display: 28MHz • FM mode • MIC GAIN CONTROL: MAX. CW • Apply an AF signal to the MIC CONNECTOR at 1.0kHz 10mV 	REAR PANEL	Connect a deviation meter to the ANTENNA CONNECTOR through an attenuator.		±4.7kHz	MAIN	R292			

MAIN UNIT

C36 SWR Meter adjustment point
FILTER UNIT)

R96 SWR Meter adjustment point

R95 SWR Meter adjustment point

R106 Vc Meter adjustment point

R292 FM Deviation adjustment point

R451 Transmit Start Time
adjustment point

D13 Transmit Start Time
measurement location

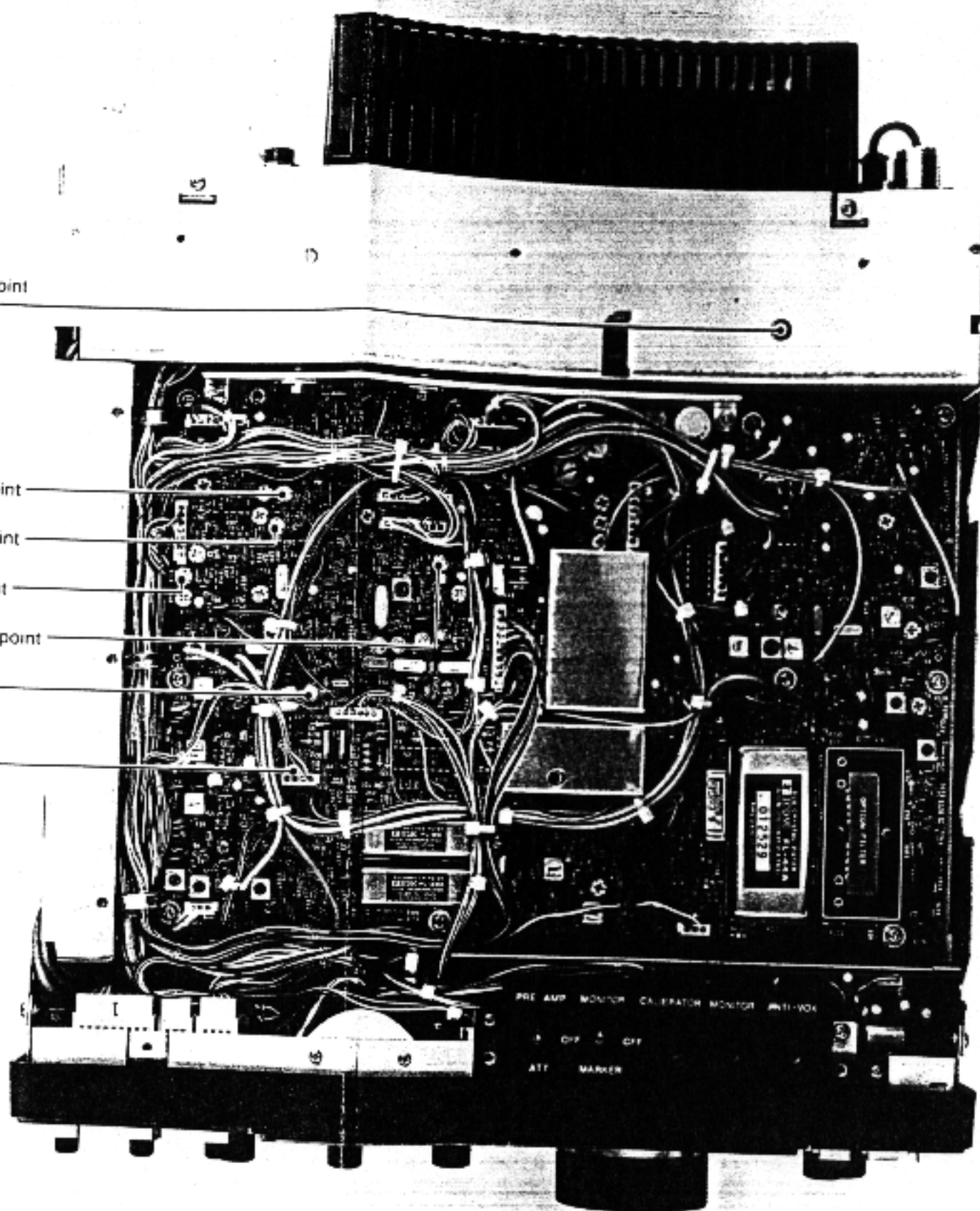

RF UNIT

J8 Transmit Start Time measurement location

