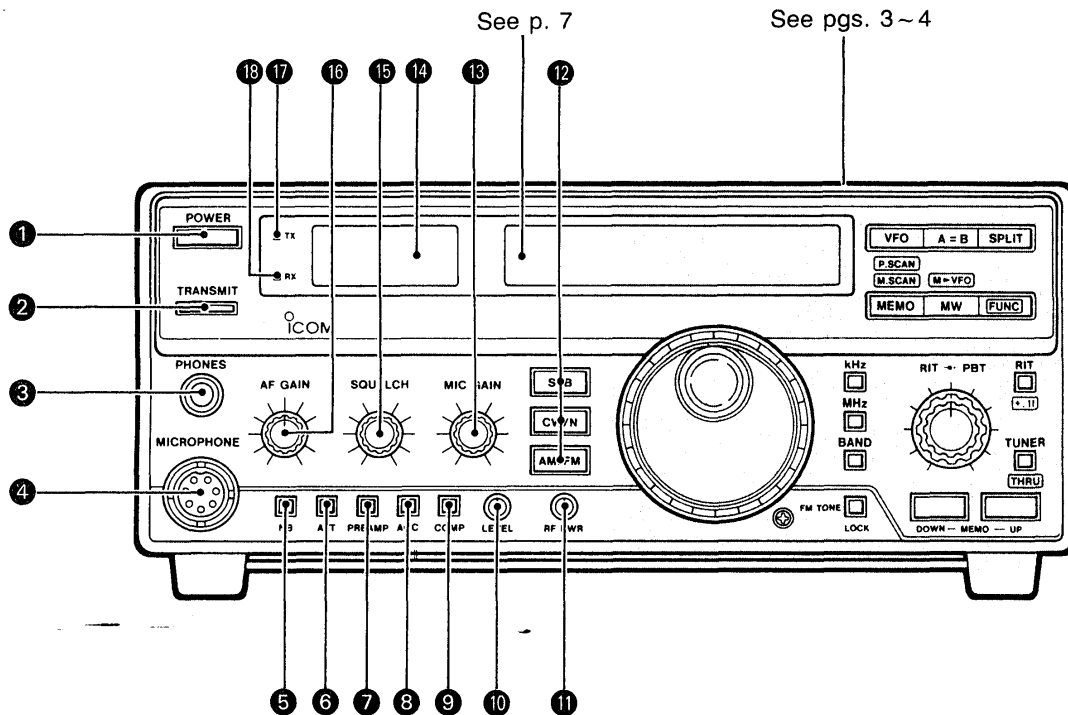

TABLE OF CONTENTS

IMPORTANT	i	5 SCANS	33 ~ 34
PRECAUTIONS	i	■ Scan types	33
EXPLICIT DEFINITIONS	i	■ Pre-operation	33
UNPACKING	i	■ Programmed scan operation	34
TABLE OF CONTENTS	ii	■ Memory scan operation	34
1 PANEL DESCRIPTION	1 ~ 8	■ Selected mode memory scan operation	34
■ Front panel	1	6 MAINTENANCE AND ADJUSTMENT ...	35 ~ 40
■ Rear panel	5	■ Disassembling the transceiver	35
■ Function display	7	■ Fuse replacement	37
■ Microphone (HM-12)	8	■ Resetting the CPU	37
2 INSTALLATION AND CONNECTIONS ...	9 ~ 16	■ CPU backup battery	37
■ Unpacking	9	■ Frequency calibration (approximate)	38
■ Mounting the transceiver	9	■ Main dial brake adjustment	38
■ Antenna	9	■ Cleaning	38
■ Connections chart	10	■ CW side tone level preset	39
■ Power supply connections	11	■ Advanced scan functions	39
■ Linear amplifier connections	12	■ BFO adjustment	39
■ Antenna tuner connections	13	■ RIT adjustment	40
■ AFSK terminal unit connections	14	■ HF bands PA idling current	40
■ Remote jack (CI-V) information	15	7 OPTIONS INSTALLATION	41 ~ 42
3 OPERATION	17 ~ 28	■ UI-7 AM·FM unit	41
■ Initial settings	17	■ UT-30 programmable tone encoder unit ...	41
■ Basic operation	17	■ MB-23 carrying handle	41
■ Mode types (VFO/Memory)	18	■ FL-100 or FL-101 CW narrow filter	42
■ Frequency setting	19	■ CR-64 high-stability crystal unit	42
■ Receiving	21	8 TROUBLESHOOTING	43 ~ 44
■ Transmitting	23	9 INSIDE VIEWS	45 ~ 48
■ RIT and “+ Δ f”	25	■ IC-728 main unit	45
■ PBT operation	25	■ IC-728 PLL unit	46
■ Split frequency operation	26	■ IC-729 main unit	47
■ Cross mode operation	26	■ IC-729 PLL unit	48
■ Optional antenna tuner operation	27	10 SPECIFICATIONS	49
4 MEMORY CHANNELS	29 ~ 32	11 OPTIONS	50 ~ 52
■ Memory channels	29	SCHEMATIC DIAGRAM	SEPARATE
■ Memory channel selection	29	Technical information	
■ Memory channel programming	30	• ACC sockets	6
■ Frequency transferring	31	• Microphone connector	
■ Programming split memory channels		and HM-12 schematic diagram	8
(for accessing a repeater)	32		

1 PANEL DESCRIPTION

■ Front panel



- ① **POWER SWITCH [POWER]** (pgs. 21, 23)
Turns power ON and OFF.



- ② **TRANSMIT SWITCH [TRANSMIT]** (p. 23)
Selects transmitting or receiving.



- ③ **HEADPHONE JACK [PHONES]** (p. 21)
Accepts headphones.
• Headphones with 4 ~ 16 Ω impedance can be used.
• When headphones are connected, the internal speaker does not function.

- ④ **MICROPHONE CONNECTOR [MICROPHONE]**
Accepts the supplied microphone.
• An optional Icom desktop microphone can be used.
• See p. 8 for microphone connector information.

- ⑤ **NOISE BLANKER SWITCH [NB]** (p. 21)
Turns the noise blanker ON and OFF.



FUNCTION

The **noise blanker** reduces pulse-type noise such as that generated by automobile ignition systems. This function is not available for AM and FM, or non-pulse-type noise.

- ⑥ **ATTENUATOR SWITCH [ATT]** (p. 21)
Turns the 20 dB attenuator ON and OFF.



FUNCTION

The **attenuator** prevents the desired signal from distorting when very strong signals are near the desired frequency or when very strong electric fields from a broadcasting station are near your location.

- ⑦ **PREAMP SWITCH [PREAMP]** (p. 21)
Turns the preamp ON and OFF.



FUNCTION

The **preamp** amplifies received signals in the front end circuit to improve the S/N ratio and sensitivity. Turn this function ON when receiving weak signals.

- ⑧ **AGC SWITCH [AGC]** (p. 21)
Changes the time constant of the AGC circuit.



FUNCTION

The **AGC** controls receiver gain to produce a constant audio output level even when the received signal strength is varied by fading, etc. Use AGC slow for normal operation and select AGC fast depending on the receiving condition. AGC does not function in FM mode.

9 SPEECH COMPRESSOR SWITCH [COMP]

(p. 23)

Turns the speech compressor ON and OFF.

- The compressing level must be adjusted properly. See 10 for details.



FUNCTION

The **speech compressor** compresses the audio input to increase the average audio output level. Therefore talk power is increased. This function is effective for long distance communication or when propagation conditions are poor.

10 SPEECH COMPRESSION LEVEL CONTROL [LEVEL] (p. 23)

Adjusts the compression level.

- This control is available only when the speech compressor is ON.

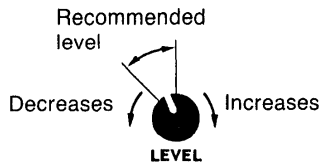

11 RF POWER CONTROL [RF PWR] (p. 23)

Continuously varies the RF output power from minimum to maximum.



MODE	Max. RF output		Min. RF output	
	HF	50 MHz*1	HF	50 MHz*1
SSB	100 W	10 W	10 W	1 W
CW	100 W	10 W	10 W	1 W
FM*2	100 W	10 W	10 W	1 W
AM*2	40 W	4 W	10 W	1 W

*1 For the IC-729.

*2 An optional UI-7 AM-FM UNIT is required for the IC-728.

12 MODE SWITCHES (pgs. 21, 23)

Select the desired operating mode.

- SSB** selects USB and LSB alternately.
- CW/N** selects "normal CW" and "CW-Narrow" alternately.
 - An optional FL-100 or FL-101 CW filter is required for CW-Narrow receiving.
- AM/FM** selects AM and FM alternately.
 - The IC-728 requires an optional UI-7 AM-FM UNIT for AM transmitting and FM transmitting/receiving.

13 MIC GAIN CONTROL [MIC GAIN] (p. 23)

Adjusts microphone input gain.

- See p. 23 for mic gain setting details.

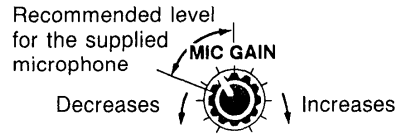

14 S/RF METER (pgs. 21, 23)

Shows the signal strength while receiving. Shows the relative output power while transmitting.

15 SQUELCH CONTROL [SQUELCH] (p. 21)

Adjusts the squelch threshold level.

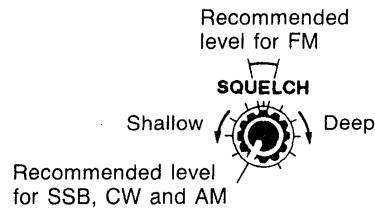

FUNCTION

The **squelch** removes the noise output from the speaker (closed condition) when no signal is received. The squelch is particularly effective for FM. It is also available for other modes.

SETTING PROCEDURE

Squelch setting: When operating in FM, first rotate the control fully counterclockwise. Then, rotate the control clockwise to the point where the noise just disappears. This is the best position. The squelch does not open for weak signals when it is set too deep.

16 AF GAIN CONTROL [AF GAIN] (pgs. 21, 23)

Varies the audio output level from the speaker.

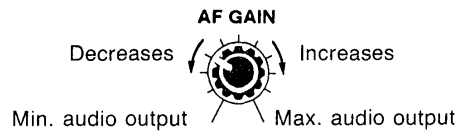

17 TRANSMIT/ALC INDICATOR [TX] (p. 23)

Lights while transmitting.

- While ALC is activated, the LED brightness increases.

FUNCTION

The **ALC circuit** automatically limits RF output power by controlling the input level of the RF power amplifier. This prevents transmitting distorted signals when the input signal level exceeds the allowable level.

18 RECEIVE INDICATOR [RX] (p. 21)

Lights during receiving when the squelch is open.

1 PANEL DESCRIPTION

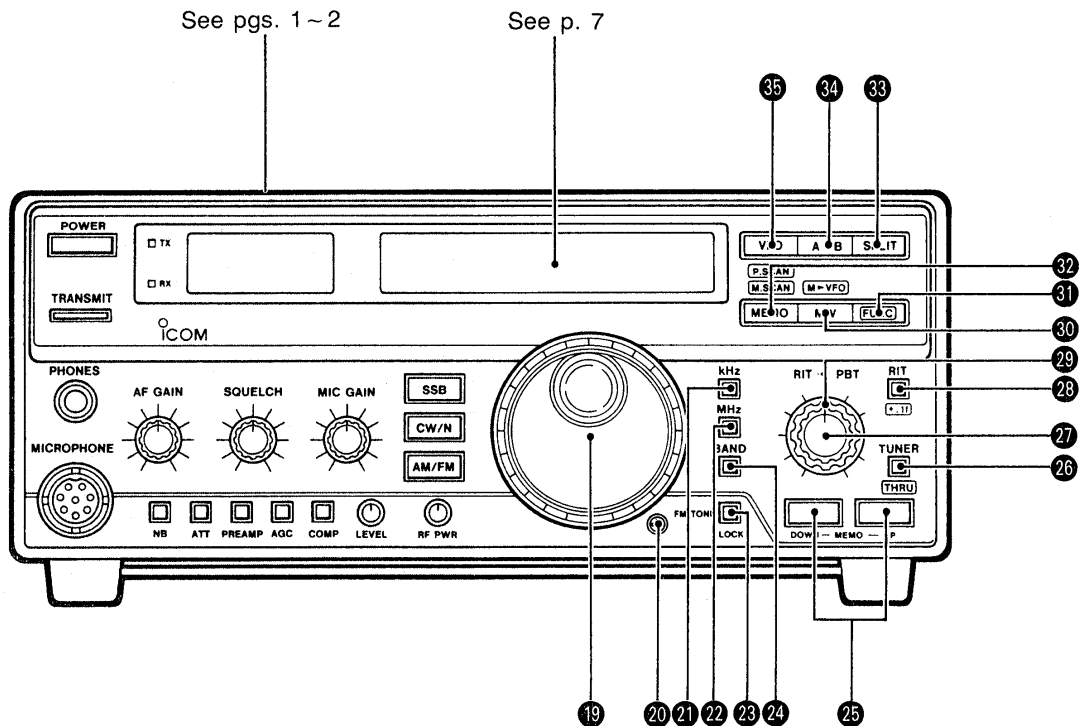

19 MAIN DIAL (p. 19)

Changes the displayed frequency.
 • When the band change indicator is displayed, the main dial changes the band.

20 BRAKE ADJUSTMENT SCREW (p. 38)

Adjusts the main dial tension.



21 kHz TUNING STEP SWITCH [kHz] (p. 20)

Turns the 1 kHz tuning step ON and OFF.

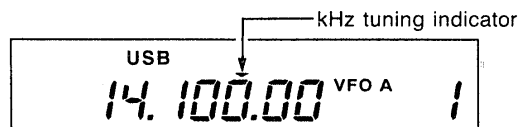

• While this indicator is displayed, the main dial changes the displayed frequency in 1 kHz steps.

22 MHz TUNING STEP SWITCH [MHz] (p. 19)

Turns the 1 MHz tuning step ON and OFF.

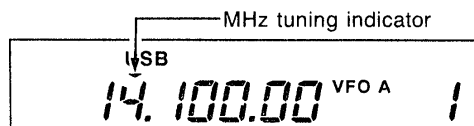

• While this indicator is displayed, the main dial changes the displayed frequency in 1 MHz steps.

23 DIAL LOCK SWITCH [LOCK] (pgs. 21, 23)

- Turns the dial lock function ON and OFF.
 • The dial lock function electronically locks the main dial.

- Also turns the subaudible tone encoder ON and OFF in FM mode at the same time.

• To transmit a subaudible tone, an optional UT-30 PROGRAMMABLE TONE ENCODER UNIT is required.

- | | | | |
|--------------------------|-------------------------------|--------------------------|------------------------------|
| <input type="checkbox"/> | • Dial lock: OFF | <input type="checkbox"/> | • Dial lock: ON |
| <input type="checkbox"/> | • Tone encoder (FM only): OFF | <input type="checkbox"/> | • Tone encoder (FM only): ON |

FUNCTION

Subaudible tones are used to access a repeater which requires such tones. The UT-30 offers you 38 kinds of subaudible tone frequencies to match your needs.

24 BAND SWITCH [BAND] (p. 19)

Turns the band change function ON and OFF.

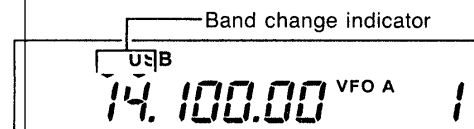

• While this indicator is displayed, the main dial changes the operating band. The previously used frequency on the selected band appears via the band stacking register. See p. 19 for details.

25 MEMORY CHANNEL UP/DOWN SWITCHES

[UP]/[DOWN] (p. 29)

- Changes the displayed memory channel number in the VFO mode.
- Changes the displayed memory channel in the memory mode.

26 ANTENNA TUNER SWITCH [TUNER]

(pgs. 27, 28)

Turns the antenna tuning ON when an optional antenna tuner is connected.

- Optional AH-3 and AT-160 HF automatic antenna tuners are available.

27 RIT CONTROL [RIT] (p. 25)

Shifts the receive frequency while the RIT function is ON.

- Rotate the control clockwise to increase the receive frequency, or rotate the control counterclockwise to decrease the receive frequency.

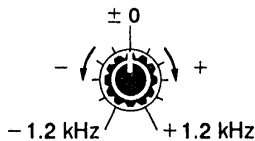

28 RIT SWITCH [RIT] (p. 25)

Turns the RIT function ON and OFF.

- Push it to turn the function ON and push it again to turn the function OFF.
- "RIT" is indicated when the function is ON.
- Use the RIT control to vary the RIT frequency.

29 PASSBAND TUNING CONTROL [PBT] (p. 25)

Adjusts the passband selectivity of the IF filter for through frequencies.

- Set to the center position when not in use.

FUNCTION

The **PBT** function makes the IF passband width narrow to reject interference. The PBT is specially effective in SSB operation and not available in FM operation.

[Simplified example of the PBT function]

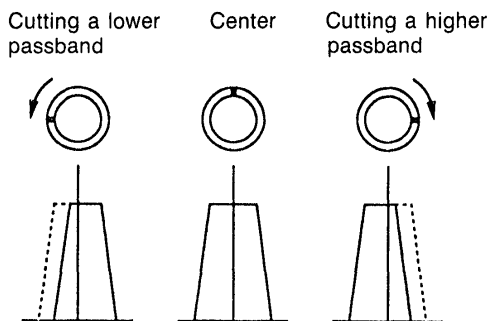

30 MEMORY WRITE SWITCH [MW]

Stores the displayed frequency and mode into the displayed memory channel.

31 FUNCTION SWITCH [FUNC]

Activates the secondary functions of some switches.

SWITCH	FUNCTION
[FUNC] + [VFO]	Starts programmed scan. (p. 34)
[FUNC] + [MEMO]	- Starts memory scan. (p. 34) - Starts selected mode memory scan when [LOCK] has been pushed IN in advance. (p. 34)
[FUNC] + [MW]	Transfers the memory contents to the selected VFO. (p. 31)
[FUNC] + [RIT]	Adds the RIT frequency to the displayed frequency. (p. 25)
[FUNC] + [TUNER]	Bypasses the connected antenna tuner. (pgs. 27 ~ 28)
[FUNC] + [kHz]	Changes the tuning step with the main dial while holding [kHz]. (p. 20)
[FUNC] + [BAND]	Turns the 10 Hz digit indication ON and OFF. (p. 20)
[FUNC] + [AM/FM]	Turns the auto tuning step function ON and OFF for AM and FM. (p. 20)

- While "FUNC" is indicated in the function display, secondary functions can be activated.
- To turn OFF "FUNC," push the switch again.

32 MEMORY READ SWITCH [MEMO] (p. 18)

Selects the memory mode and VFO mode alternately.

33 SPLIT SWITCH [SPLIT] (p. 26)

Turns the split frequency operation ON and OFF.

- Push the switch to turn the function ON and push it again to turn the function OFF.
- "SPLIT" is indicated when the function is ON.

34 VFO EQUALIZATION SWITCH [A = B] (p. 26)

Equalizes the frequency and mode of the two VFOs.

- The rear (undisplayed) VFO frequency and mode are equalized to the front (displayed) VFO frequency and mode.

35 VFO SWITCH [VFO] (p. 18)

Selects VFO A and VFO B alternately.

- When the memory mode has been selected, the previously used VFO is selected by pushing this switch.

1 PANEL DESCRIPTION

■ Rear panel

The figure below shows the rear panel of the IC-729.

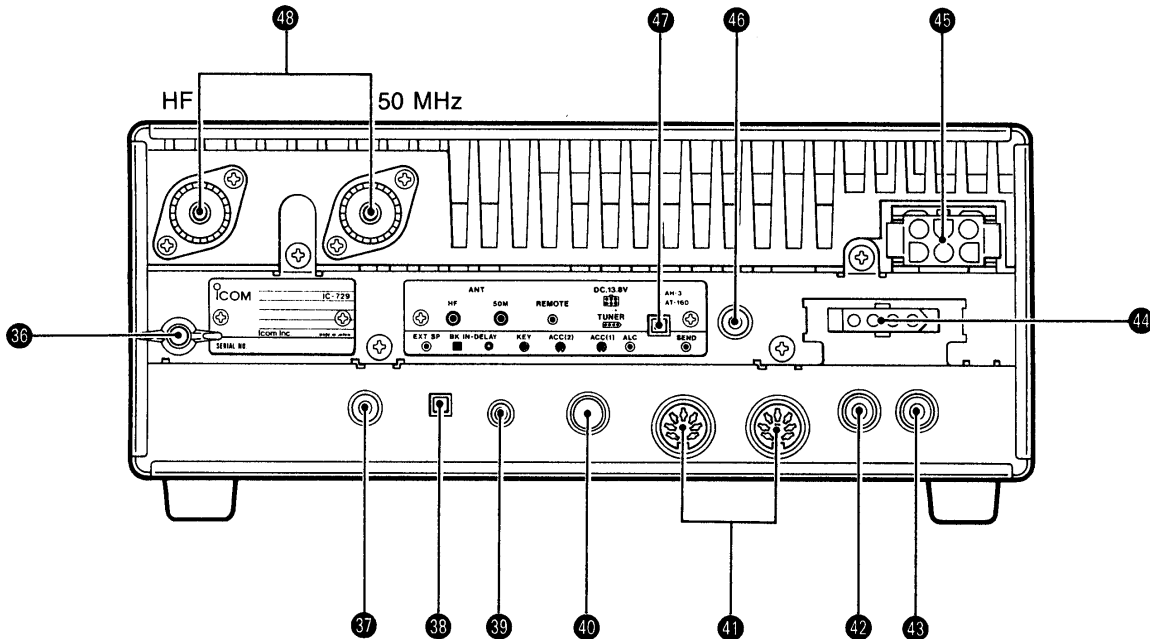

- 36 **GROUND TERMINAL** (p. 9)
Connect this terminal to a ground to prevent electrical shocks, TVI, BCI and other problems.

- 37 **EXTERNAL SPEAKER JACK [EXT SP]** (p. 10)
Accepts a 4~16 Ω speaker.

- 38 **CW BREAK-IN SWITCH [BK IN]** (p. 24)
Turns the CW break-in operation ON and OFF



FUNCTION

The **CW break-in** function starts transmission without pushing the transmit switch or PTT switch when the CW key is ON. Then, automatically returns to receive when the CW key is OFF. The IC-728/729 is equipped with a semi break-in system.

- 39 **CW BREAK-IN DELAY CONTROL [DELAY]** (p. 24)
Adjusts the transmit-to-receive switching delay time for the CW break-in operation.



- Set delay time depending on the CW speed or your preference.

- 40 **CW KEY JACK [KEY]** (p. 10)
Accepts a straight key or electronic keyer with a standard 1/4 inch 3-conductor plug.

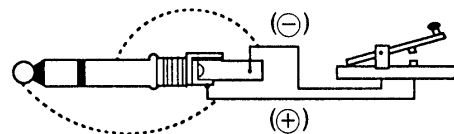

- 41 **ACCESSORY SOCKETS [ACC (1) and (2)]**
Enables connection to external equipment such as a linear amplifier, an automatic antenna tuner, TNC for data communications.
• See the page at right for socket information.

- 42 **ALC INPUT JACK [ALC]** (p. 12)
Connects to the ALC output jack of a non-Icom linear amplifier.
• See p. 2 for the ALC function.

- 43 **SEND CONTROL JACK [SEND]** (p. 12)
Goes to ground while transmitting to control external equipment such as a linear amplifier.

- 44 **TUNER CONTROL SOCKET [TUNER]** (p. 13)
Accepts the control cable from the optional AH-3 or AT-160 antenna tuner.

- 45 **DC POWER SOCKET [DC. 13.8V]** (p. 11)
Accepts 13.8 V DC through the supplied DC power cable.

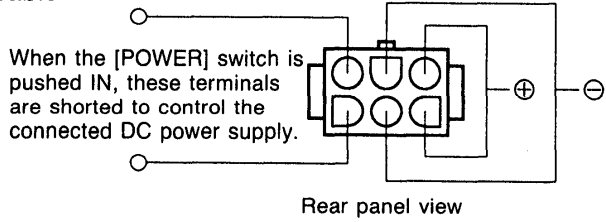

- 47 **TUNER SELECTION SWITCH** (p. 13)
Selects the connected antenna tuner, AH-3 or AT-160.
 - "AH-3" or "AT-160" appears for 1 sec. on the function display when this switch's setting is changed.
 - No function for the AT-150 and IC-AT500. Either position is acceptable for these tuners.



- 46 **CI-V REMOTE CONTROL JACK** (pgs. 15, 16)
Designed for use with a PC for remote operation of transceiver functions.

- 48 **ANTENNA CONNECTORS [HF]/[50 M]** (p. 9)
Accepts a 50 Ω antenna with a PL-259 plug to each connector.
 - The IC-728 has only the [HF] antenna connector.

TECHNICAL INFORMATION

• **ACC SOCKETS**

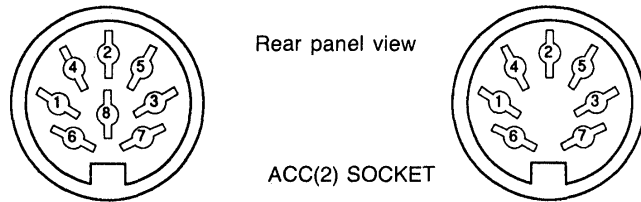

ACC(1) SOCKET

PIN NO.	PIN NAME	DESCRIPTION	SPECIFICATIONS
1	NC	No connection.	—
2	GND	Connects to ground.	Connected in parallel with ACC(2) pin 2.
3	SEND	Input/output pin. Goes to ground when transmitting. When grounded, transmits.	Ground level : -0.5~0.8 V Input current : Less than 20 mA Connected in parallel with ACC(2) pin 3.
4	MOD	Modulator input. Connects to a modulator.	Input impedance : 10 kΩ Input level : Approx. 100 mV rms.
5	AF	AF detector output. Fixed, regardless of [AF] position.	Output impedance : 4.7 kΩ Output level : 100~350 mV rms
6	SQLS	Squelch output. Goes to ground when squelch opens.	SQL open : Less than 0.3 V/5 mA SQL closed : More than 6.0 V/100 μA
7	13.8 V	13.8 V output when power is ON.	Output current : Max. 1 A Connected in parallel with ACC(2) pin 7.
8	ALC	ALC voltage input.	Control voltage : -4~0 V Input impedance : More than 10 kΩ Connected in parallel with ACC(2) pin 5.

ACC(2) SOCKET

PIN NO.	PIN NAME	DESCRIPTION	SPECIFICATIONS
1	8 V	Regulated 8 V output.	Output voltage : 8 V ± 0.3 V Output current : Less than 10 mA
2	GND	Same as ACC(1) pin 2.	
3	SEND	Same as ACC(1) pin 3.	
4	BAND	Band voltage output. (Varies with amateur band)	Output voltage : 0~8.0 V
5	ALC	Same as ACC(1) pin 8.	
6	TPS	Tuner selection voltage.	Output voltage : 4~5 V
7	13.8 V	Same as ACC(1) pin 7.	

1 PANEL DESCRIPTION

■ Function display

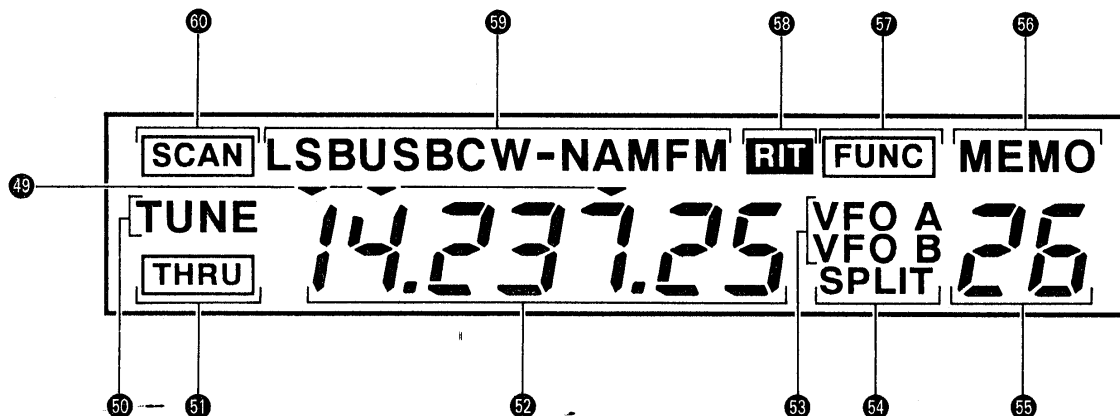

49 TUNING STEP/BAND CHANGE INDICATORS
Show the selected tuning step or show that the band change function is ON.

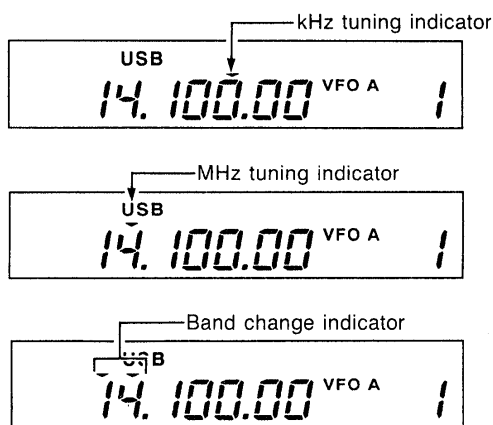

50 TUNING INDICATOR
Shows that an optional antenna tuner is connected.

- "TUNE" lights - when the connected antenna tuner (optional) has completed tuning.
- when the tuning operation has not been performed after power ON.
- "TUNE" blinks when the antenna is being tuned.

51 THROUGH INDICATOR
Shows that the connected antenna tuner (optional) is bypassed.

- "THRU" lights - when the connected antenna does not match the antenna tuner matching range.
- when the antenna tuner is manually bypassed.

52 FREQUENCY READOUT
Shows the operating frequency.

53 VFO INDICATORS
Show that the VFO mode is selected.

- Selected VFO is indicated.

54 SPLIT INDICATOR
Shows that the split frequency operation is being performed.

- This indicator blinks for 2 sec. when a split memory channel (memory channel 23 or 24) is selected.

55 MEMORY CHANNEL NUMBER READOUT
Shows the selected memory channel number.

56 MEMORY INDICATOR
Shows that the memory mode is selected.

57 FUNCTION INDICATOR
Shows that the [FUNC] switch has been pushed.

- Secondary functions can be used with some switches.

58 RIT INDICATOR
Shows that the RIT function is ON.

59 MODE INDICATORS
Show the operating mode.

60 SCAN INDICATOR
Shows that one of the scan functions is being operated.

Downloaded by
RadioAmateur.EU

■ Microphone (HM-12)

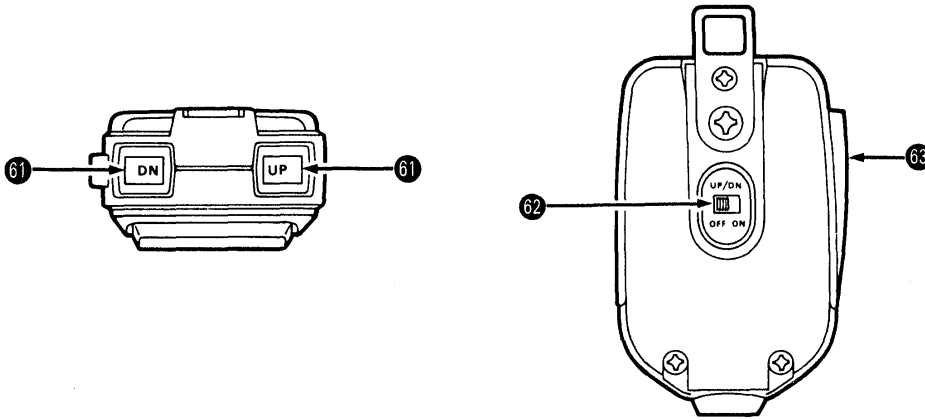

61 UP/DOWN SWITCHES [UP]/[DN]

Change the operating frequency or memory channel.

- Continuous pushing changes the frequency or memory channel number continuously.
- The up/down on/off switch must be set to "ON" to use these switches. See 62.

62 UP/DOWN ON/OFF SWITCH [UP/DN]

Turns the [UP] and [DN] switches ON and OFF.

63 PTT SWITCH

Push and hold to transmit; release to receive.

TECHNICAL INFORMATION

• MICROPHONE CONNECTOR

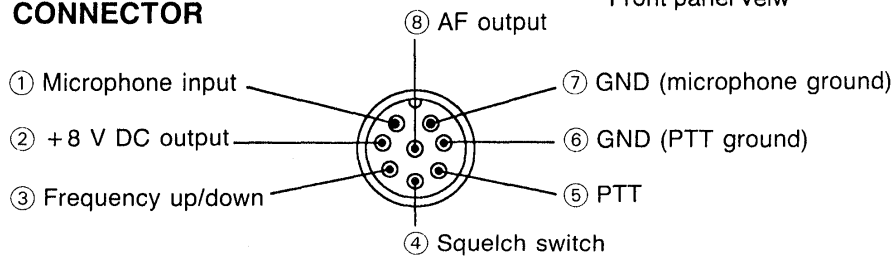

PIN. NO	FUNCTION	DESCRIPTION
2	+8 V DC output	Max. 10 mA
3	Frequency up	Ground
	Frequency down	Ground through 470 Ω
4	Squelch open	"LOW" level
	Squelch closed	"HIGH" level

CAUTION: DO NOT short pin 2 to ground as this can damage the internal 8 V regulator.

• HM-12 SCHEMATIC DIAGRAM

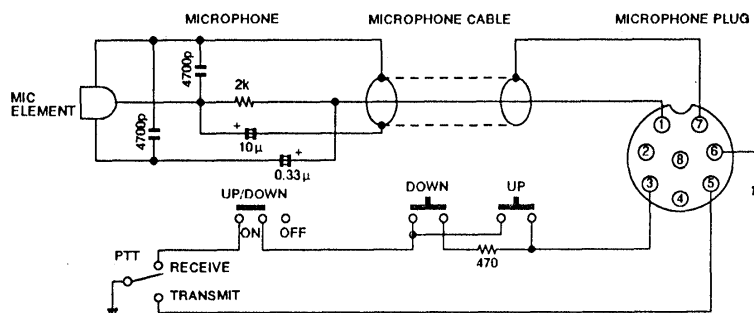

■ Unpacking

After unpacking, immediately report any damage to the delivering carrier or dealer. Keep the shipping cartons.

For a list and a diagram of accessory equipment included with the IC-728/729, see UNPACKING on the inside front page (p. i) of this manual.

■ Mounting the transceiver

Select a location for the transceiver that allows adequate air circulation, free from extreme heat, cold, or vibrations, and away from TV sets, radios and other electro-magnetic sources.

For mobile installations, an optional IC-MB5 MOBILE MOUNTING BRACKET is available. Select a location which can support the weight of the transceiver and that does not interfere with the operation of the vehicle.

ADJUSTMENT ANGLES

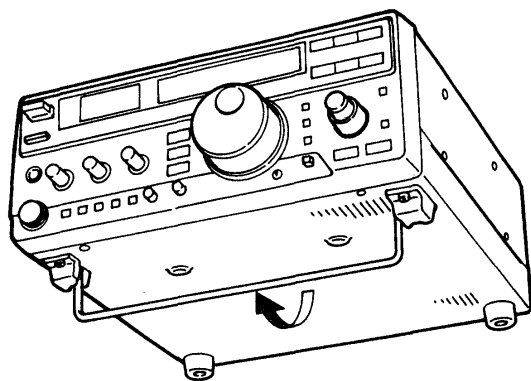

The stand on the bottom of the IC-728/729 provides two operating angles.

WIRING THE DC POWER CABLE IN YOUR CAR

Attach a rubber grommet to the DC power cable to prevent shorting.

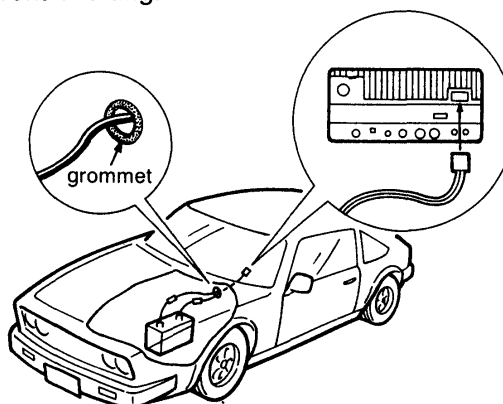

■ Antenna

Select an antenna, such as a well-matched 50 Ω antenna and feedline. The transmission line should be a coaxial cable. VSWR should be less than 1.5:1.

CAUTION: Protect your transceiver from lightning by using a lightning arrester.

PL-259 CONNECTOR INSTALLATION

① Slide the coupling ring down. Strip the cable jacket and soft solder.

② Strip the cable as shown at left. Soft solder the center conductor.

(10 mm \approx 3/8 in)

③ Slide the connector body on and solder it.

④ Screw the coupling ring onto the connector body.

GROUNDING

To prevent electrical shock, TVI, BCI and other problems, ground the transceiver through the GROUND terminal on the rear panel.

For best results, connect a heavy gauge wire or strap to a long earth-sunk copper rod. Make the distance between the GROUND terminal and ground as short as possible.

■ Connections chart

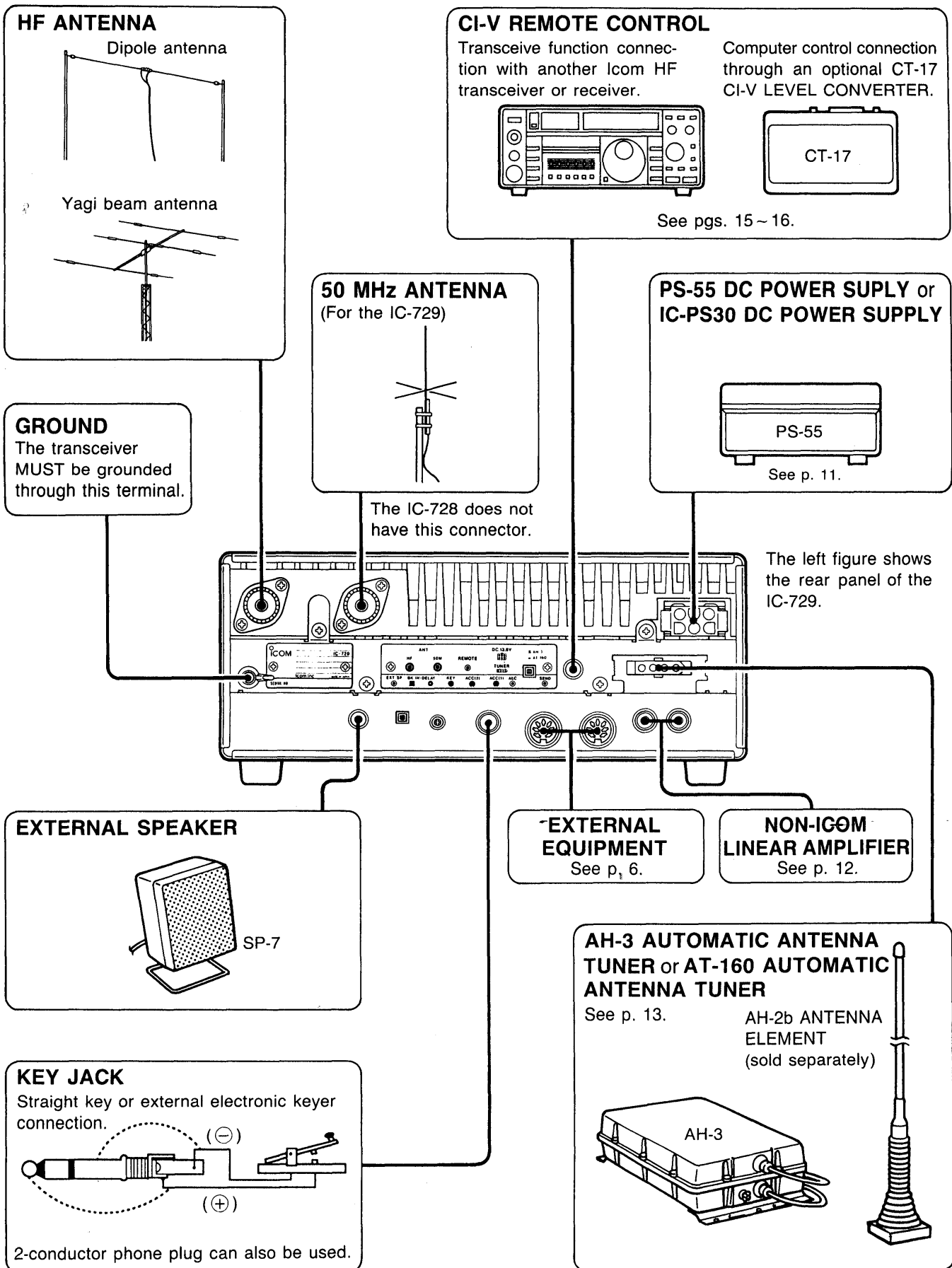

2 INSTALLATION AND CONNECTIONS

■ Power supply connections

Use an optional PS-55 or IC-PS30 DC POWER SUPPLY when operating the IC-728/729 with AC power. Refer to the diagram below.

CAUTION: Before connecting the DC power cable, check the following important items. Make sure:

- The [POWER] switch is OFF.
- Output voltage of the power source is 12~15 V when you want to use a non-Icom power supply.
- DC power cable polarity is correct.
Red : positive ⊕ terminal
Black : negative ⊖ terminal

CONNECTING AN ICOM DC POWER SUPPLY

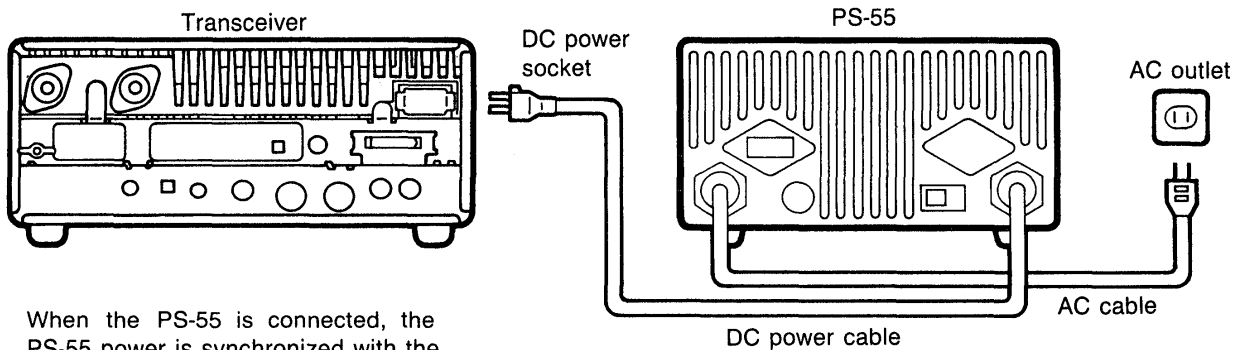

CONNECTING A NON-ICOM DC POWER SUPPLY

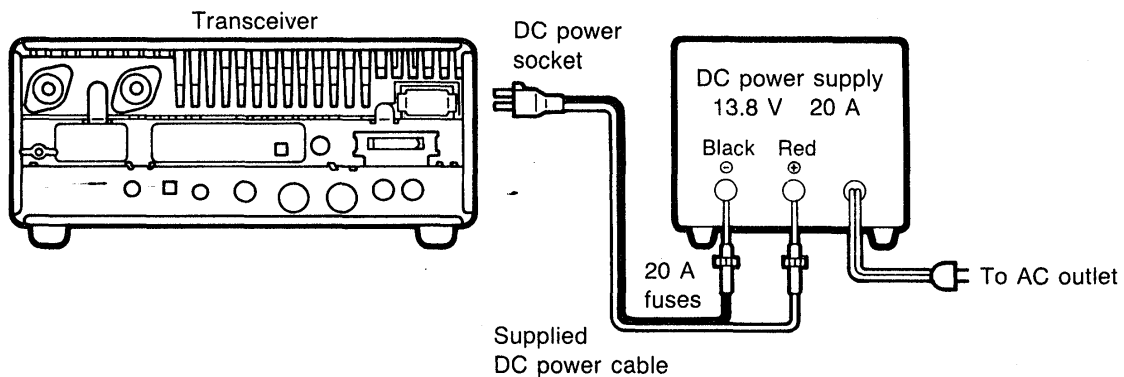

CONNECTING A VEHICLE BATTERY

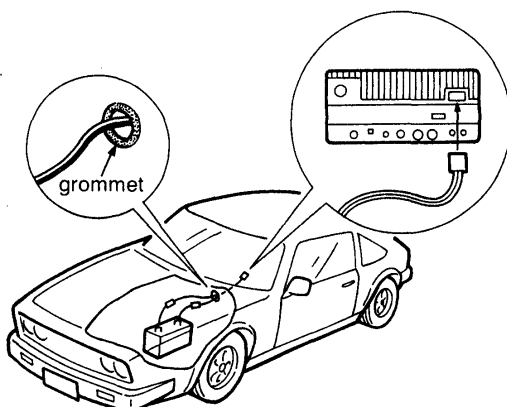

NEVER connect to a 24 V battery.

NOTE: Use terminals for the cable connections.

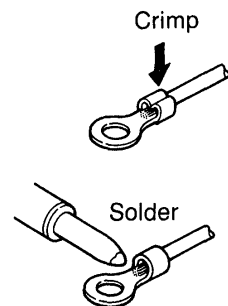
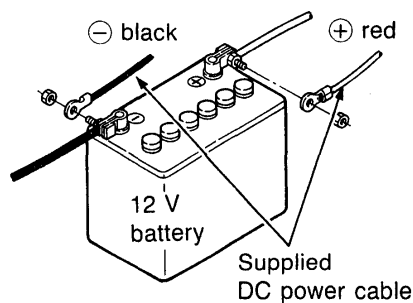

Linear amplifier connections

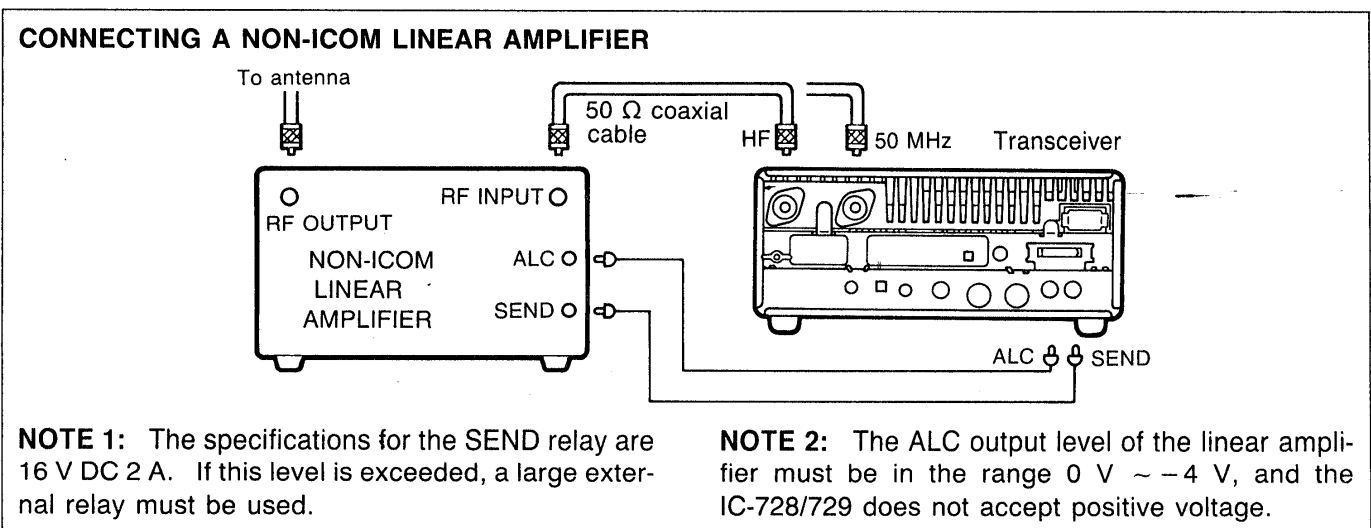
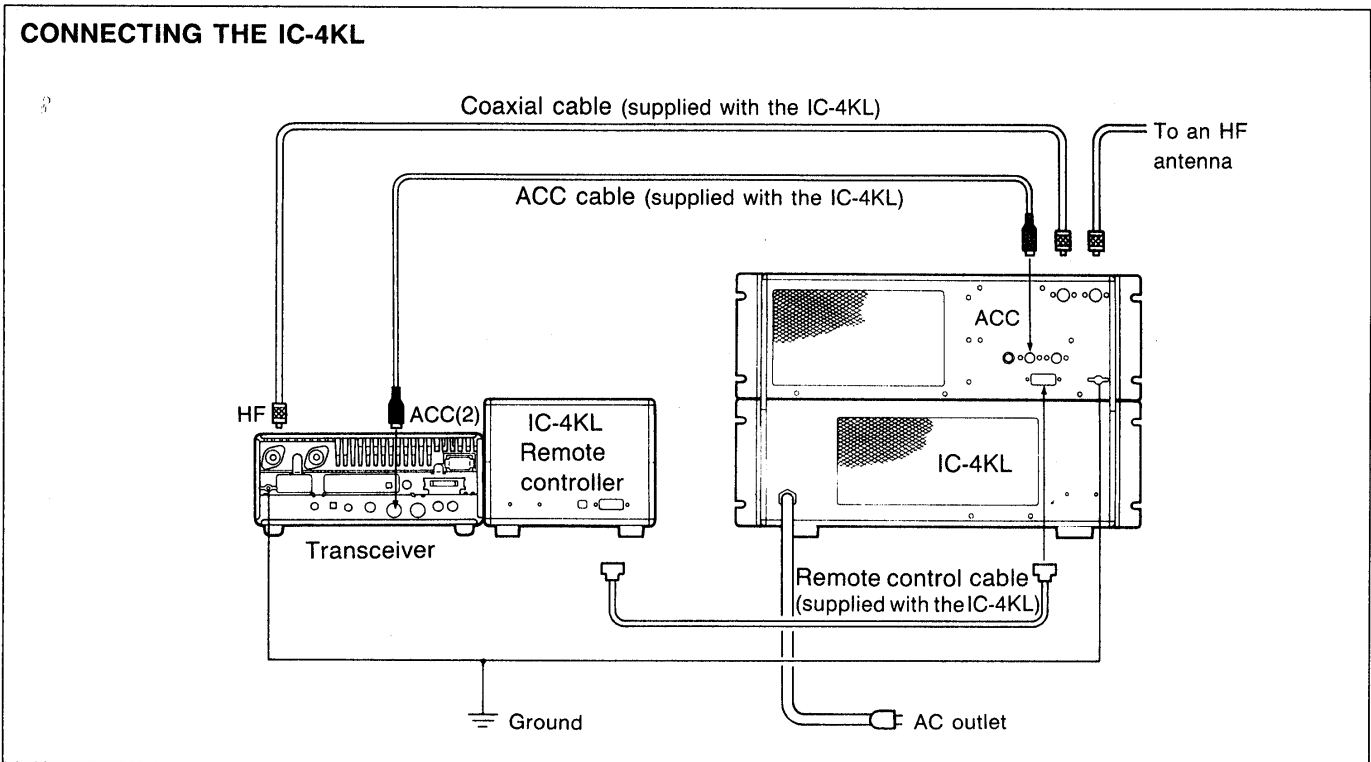
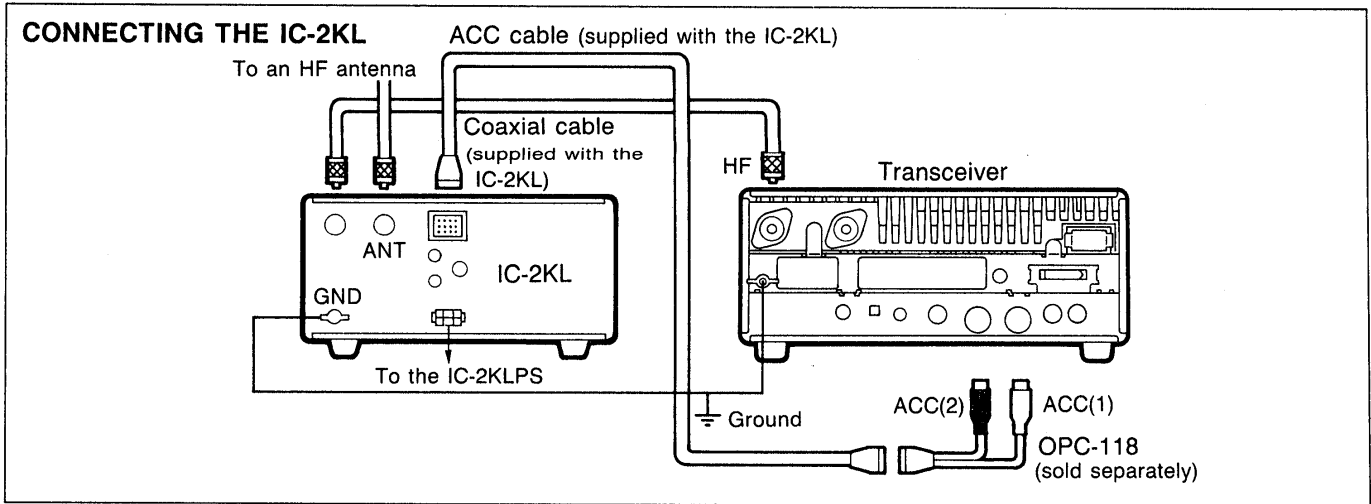

NOTE 1: The specifications for the SEND relay are 16 V DC 2 A. If this level is exceeded, a large external relay must be used.

NOTE 2: The ALC output level of the linear amplifier must be in the range 0 V ~ -4 V, and the IC-728/729 does not accept positive voltage.

2 INSTALLATION AND CONNECTIONS

■ Antenna tuner connections

CONNECTING THE AT-160

Set the tuner selection switch to AT-160.
 • Push the switch IN.

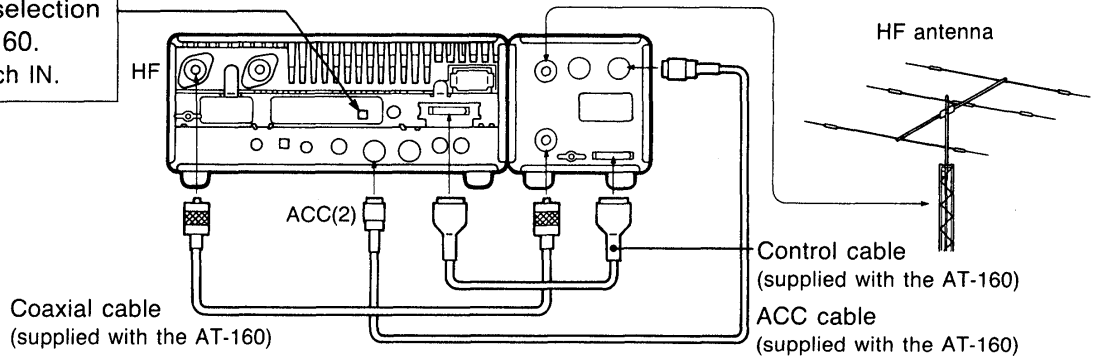

CONNECTING THE AH-3

Set the tuner selection switch to AH-3
 • Push the switch OUT.

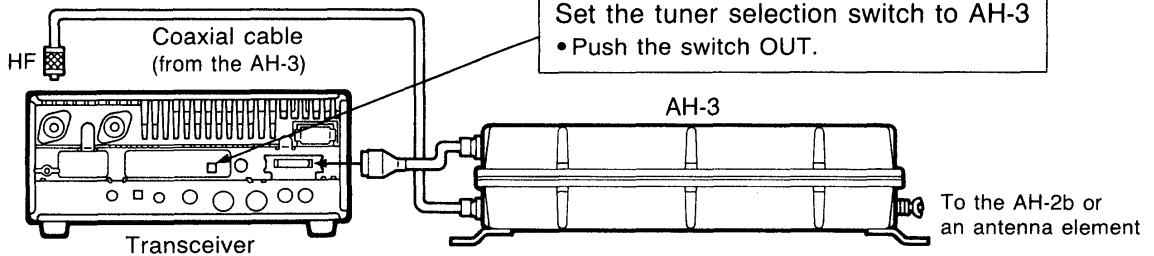

CONNECTING THE AT-150

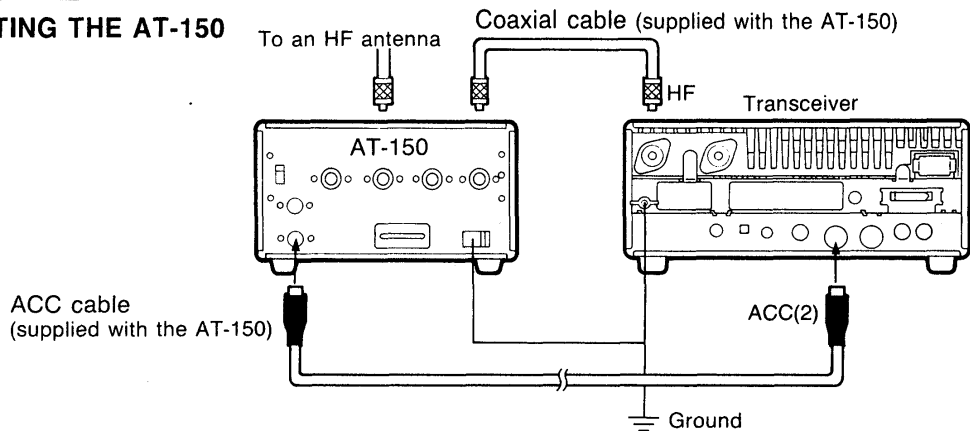

CONNECTING THE IC-AT500

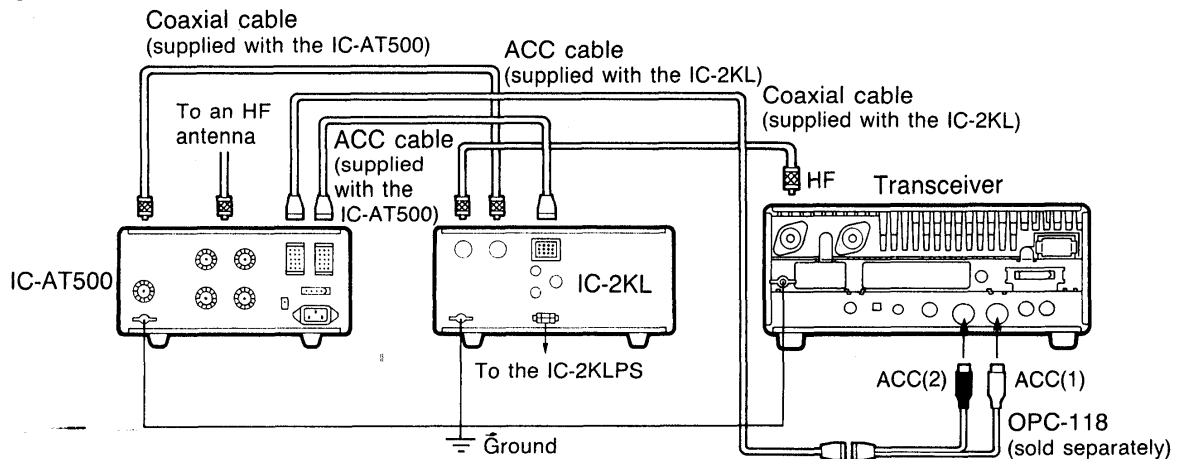

■ AFSK terminal unit connections

When operating an AFSK such as RTTY, AMTOR or packet, connect external equipment to the ACC(1) socket on the rear panel or to the microphone connector on the front panel as in the diagram below.

See pgs. 6 and 8 for ACC(1) socket information and microphone connector information.

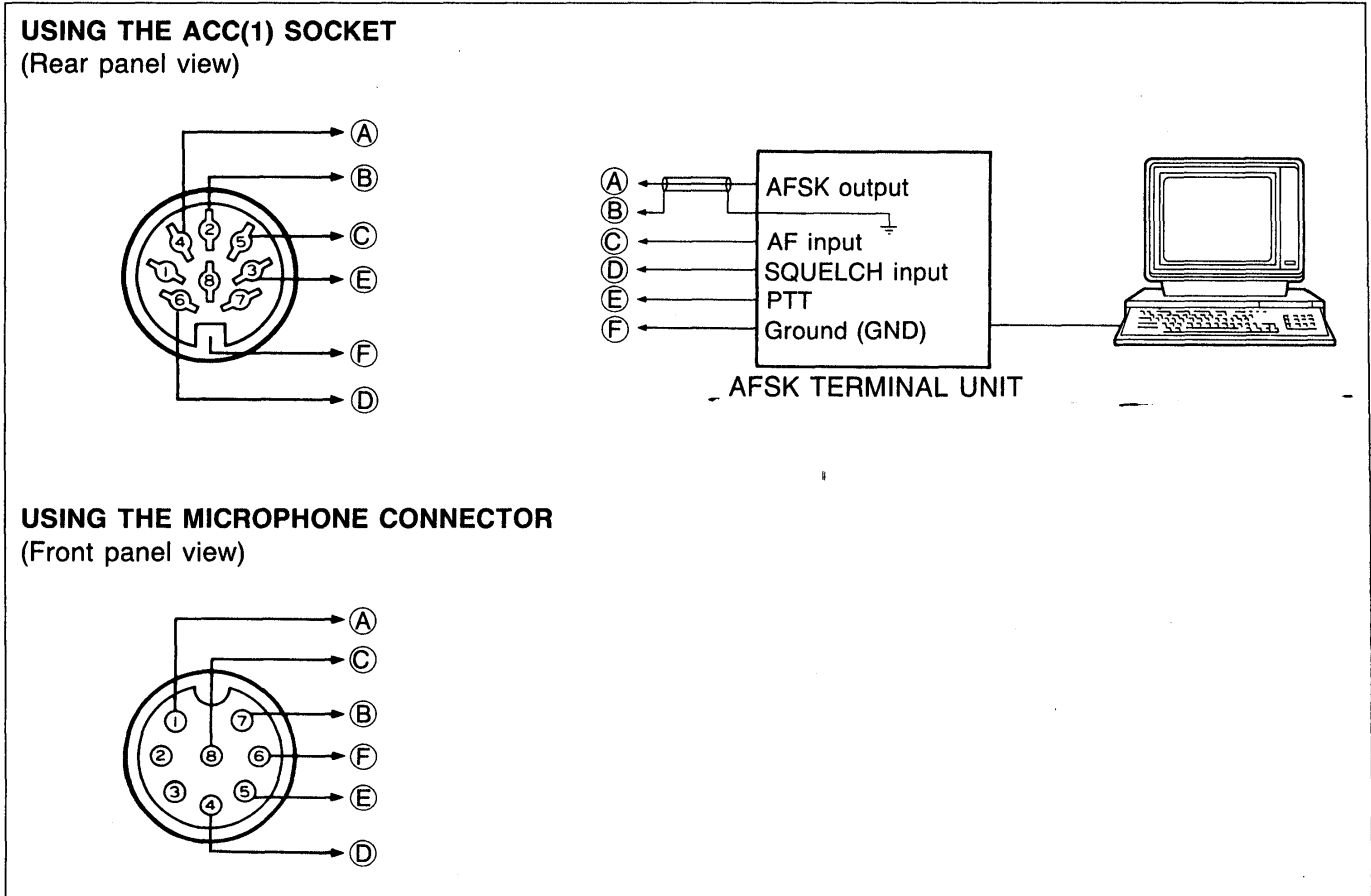

2 INSTALLATION AND CONNECTIONS

■ Remote jack (CI-V) information

The IC-728/729 can be connected through an optional CT-17 CI-V LEVEL CONVERTER to a personal computer equipped with an RS-232C port. Icom Communication Interface-V (CI-V) controls frequency, operating mode, memory channels, etc.

Up to four Icom CI-V transceivers or receivers can be connected to a personal computer equipped with an RS-232C port.

To control the transceiver, see the CT-17 instruction manual for details.

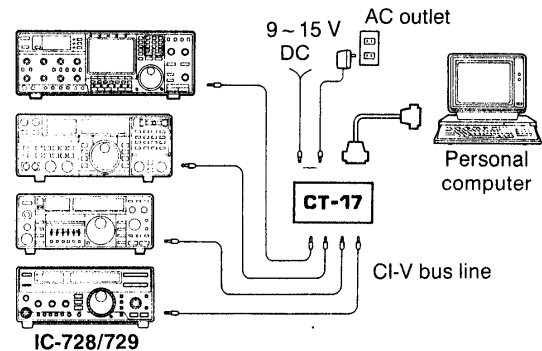

• Setting the CI-V condition with the diode matrix

Transmitters and receivers using the Icom CI-V system exchange serial information in the packet format. The contents of a data packet can be changed by the diode matrix.

Insert the required diodes (1SS133, 1SS53, etc.) or cut the unnecessary diodes to change the diode matrix. See the figure on the right page for the location of diodes.

BAUD RATE

Baud rate is the data transfer rate. The standard baud rate for the Icom CI-V is 1200 bps.

BAUD RATE (bps)	DIODE	
	D2	D3
9600	Insert diode	—
1200	—	Insert diode
300	Insert diode	Insert diode

: Default

FREQUENCY DATA

When connecting the transceiver with the IC-735 for a transceive function, change the value to 4 bytes.

FREQUENCY DATA	DIODE (D4)
4 bytes	No diode (Cut D4)
5 bytes	Insert diode

: Default

ADDRESS

You can designate an address for your IC-728 or IC-729.

The IC-728 has the address of 38H (56) and the IC-729 has the address of 3AH (58) as default values preset at the factory.

Figures marked with an H are hexadecimals and bracketed figures () are decimals.

Diode matrix for the IC-728 38H (56)

DIODE						
D57 (1)	D58 (2)	D59 (4)	D60 (8)	D61 (16)	D62 (32)	D63 (64)
—	—	—	Insert diode	Insert diode	Insert diode	—

: Default

Diode matrix for the IC-729 3AH (58)

DIODE						
D57 (1)	D58 (2)	D59 (4)	D60 (8)	D61 (16)	D62 (32)	D63 (64)
—	Insert diode	—	Insert diode	Insert diode	Insert diode	—

: Default

TRANSCIVE

Transceive operation is possible with the IC-728/729 and another Icom transceiver or receiver.

Transceive operation means the IC-728/729 is used as a transmitter and another connected transceiver (or receiver) is used as a receiver, or vice versa.

TRANSCIVE	DIODE (D64)
ON	Insert diode
OFF	No diode (Cut D64)

: Default

DIODE LOCATION

Diodes are located on the PLL UNIT as shown in the figure below.

See pgs. 35 ~ 36 for transceiver disassembly information.

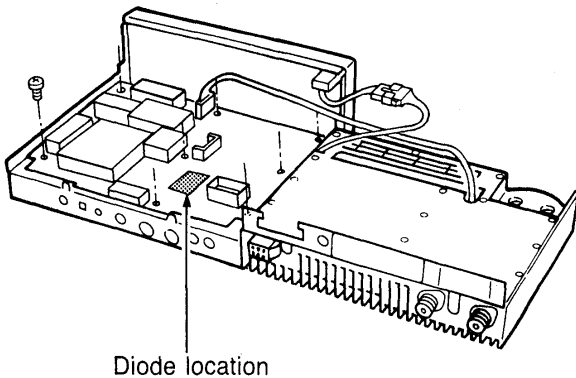

MAGNIFICATION OF THE DIODE LOCATION

IC-728

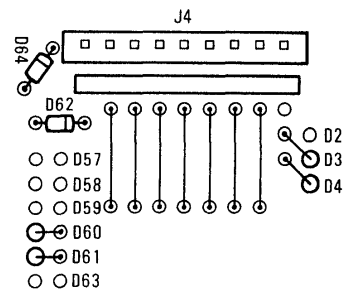

IC-729

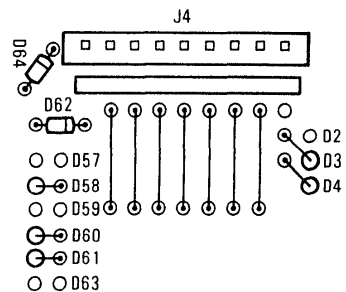

•Setting the CI-V condition with the front panel switches

With the front panel switches of the IC-728/729 you can change the transceive function and frequency

data in the same way as functions are changed via the diode matrix.

FREQUENCY DATA

•Setting the frequency data to 4 bytes

- 1) Turn the transceiver power OFF.
- 2) Push [LOCK] IN; then, while pushing [FUNC], [kHz] and [MHz], turn power ON.

•Setting the frequency data to 5 bytes

- 1) Turn the transceiver power OFF.
- 2) Push [LOCK] OUT; then, while pushing [FUNC], [kHz] and [MHz], turn power ON.

•Returning to the diode matrix setting

- 1) Turn the transceiver power OFF.
- 2) Push [LOCK] OUT; then, while pushing [FUNC], [MHz] and [BAND], turn power ON.

TRANSCIVE

•Setting transceive ON

- 1) Turn the transceiver power OFF.
- 2) Push [LOCK] IN; then, while pushing [FUNC], [kHz] and [BAND], turn power ON.

•Setting transceive OFF

- 1) Turn the transceiver power OFF.
- 2) Push [LOCK] OUT; then, while pushing [FUNC], [kHz] and [BAND], turn power ON.

•Returning to the diode matrix setting

- 1) Turn the transceiver power OFF.
- 2) Push [LOCK] OUT; then, while pushing [FUNC], [MHz] and [BAND], turn power ON.

3

OPERATION

Initial settings

Before performing the initial settings, make sure all connections required for your system are complete by referring to section 2.

Before power ON, set controls and switches as shown in the figure below.

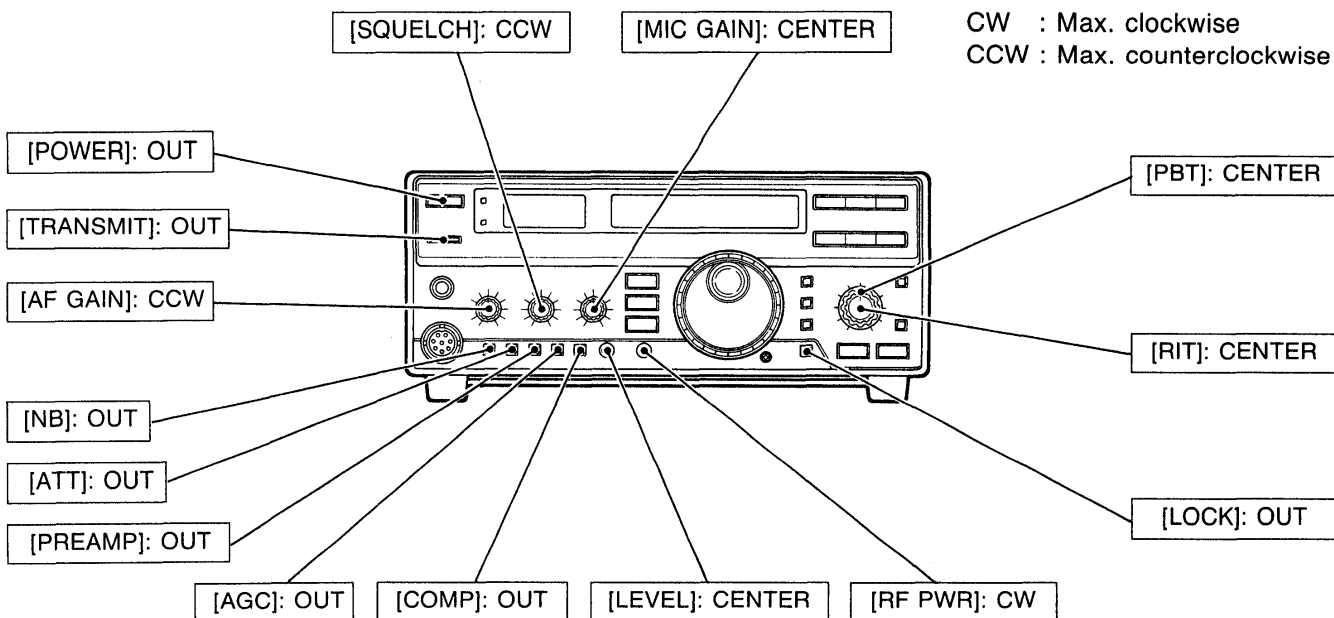

Basic operation

- 1) After the initial settings are complete, push [POWER] IN to turn power ON.

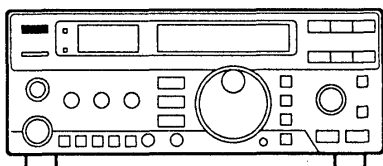

- 4) Rotate the main dial to set the desired frequency.
• See p. 19 for frequency setting details.

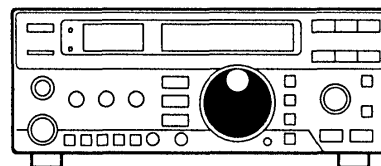

- 2) Rotate [AF GAIN] clockwise to adjust the desired audio output level.

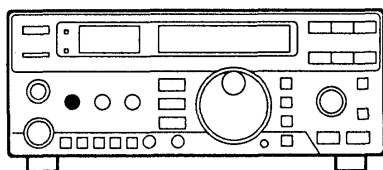

- 5) After checking that "SPLIT" or "RIT" are not indicated, push the PTT switch on the microphone to transmit. Then, release the PTT switch to return to receive.
• For CW or RTTY operation, see pgs. 22, 24.

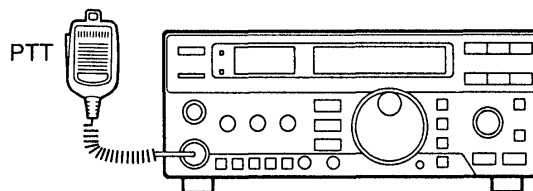

- 3) Select the desired operating mode by [SSB], [CW/N] or [AM/FM].

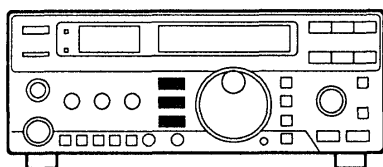

To eliminate noise, rotate [SQUELCH] clockwise until the noise disappears.

• If [SQUELCH] is rotated too deeply clockwise, the squelch will not open for weak signals.

Mode types (VFO/Memory)

The IC-728/729 has two VFOs which both receive and transmit in the VFO mode. The VFOs are called VFO A and VFO B. This dual VFO system provides tremendous operating flexibility.

The IC-728/729 has 26 memory channels in the memory mode for storing your often-used frequencies and operating modes. See pgs. 29~30 for the memory mode operation.

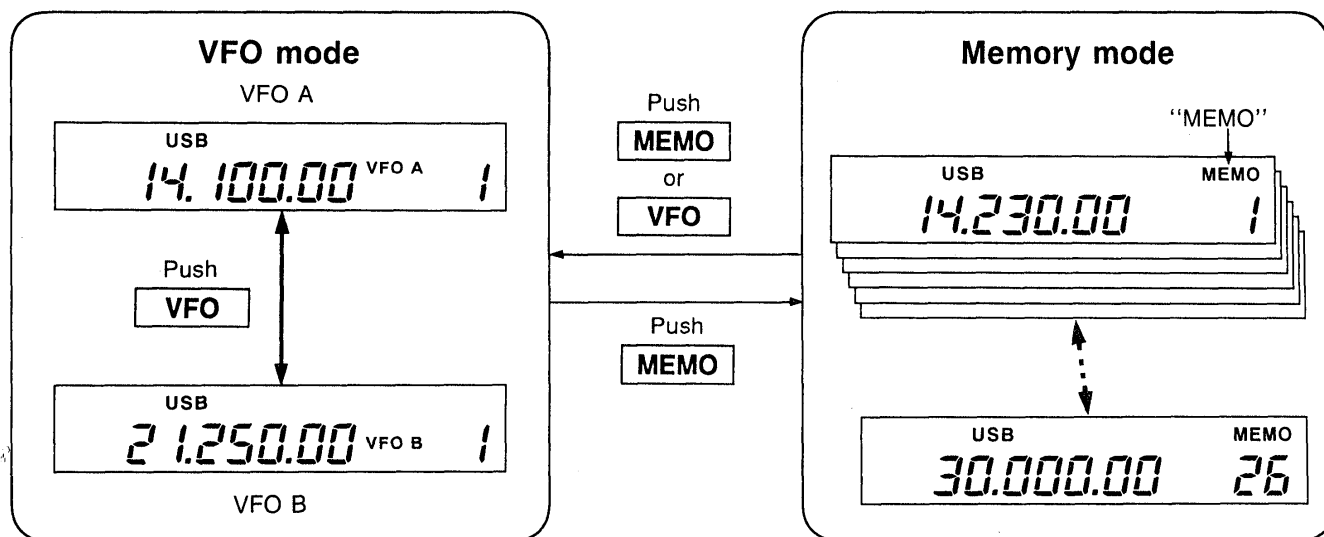

The differences between the VFO mode and the memory mode

VFO MODE

Each VFO has a frequency and operating mode. If the frequency or operating mode is changed, the VFO automatically memorizes the new frequency or new operating mode.

When the VFO is selected from another VFO or the memory mode, the last used frequency and operating mode for that VFO appear.

[EXAMPLE]

VFO A is selected.

USB 14.100.00 VFO A 1

The frequency is changed.

USB 14.123.00 VFO A 1

VFO B is selected.

USB 21.245.00 VFO B 1

VFO A is selected again.

USB 14.123.00 VFO A 1

MEMORY MODE (pgs. 29~30)

Each memory channel has a frequency and operating mode like a VFO. Even if the frequency or mode is changed, the memory channel does not memorize the new frequency or operating mode.

When the memory channel is selected from another memory channel or the VFO mode, the memorized frequency and operating mode appear.

[EXAMPLE]

Memory channel 1 is selected.

USB 14.100.00 MEMO 1

The frequency is changed.

USB 14.123.00 MEMO 1

Another memory channel is selected.

USB 21.245.00 MEMO 10

Memory channel 1 is selected again.

USB 14.100.00 MEMO 1

3 OPERATION

Frequency setting

• For ham band use

- 1) Push VFO to select the VFO mode.
 - Then, push [VFO] again to change to VFO A or VFO B.

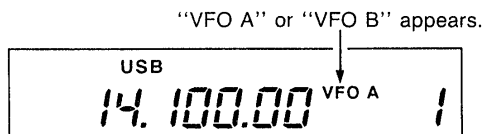

- 2) Push [BAND].

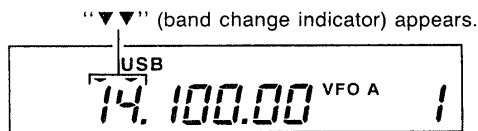

- 3) Rotate the main dial to select the desired band.

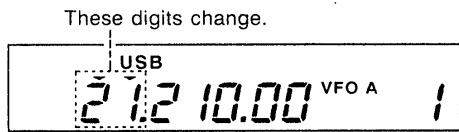

These digits and the operating mode are also changed by the band stacking register.

- 4) Push [BAND] again.

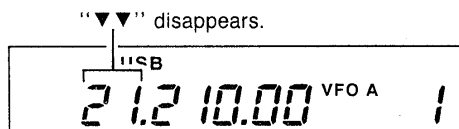

- 5) Rotate the main dial to set the desired frequency.

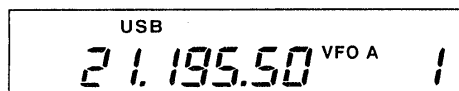

• For general coverage receiver use

- 1) Push VFO to select the VFO mode.
 - Then, push [VFO] again to change to VFO A or VFO B.

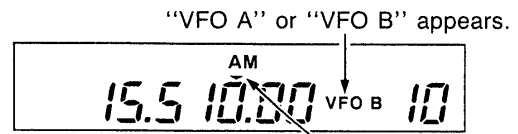

AUTO tuning step function (p. 20)

- 2) Push [MHz].

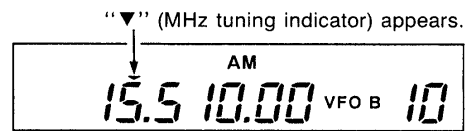

- 3) Rotate the main dial to select the desired band.

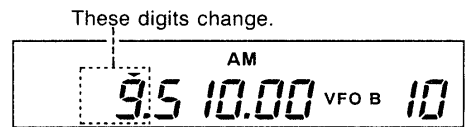

- 4) Push [MHz] again.

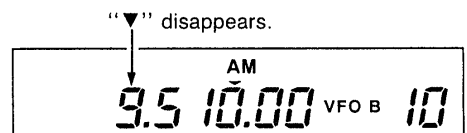

- 5) Rotate the main dial to set the desired frequency.

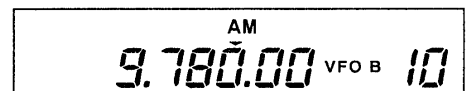

NOTE: If [LOCK] has been pushed IN, the main dial is locked and does not function.

FUNCTION

The **band stacking register** stores a frequency and an operating mode on each band. If the ham band is changed, the last used frequency and operating mode for the newly selected band automatically appear.

This function is convenient for band switching in contests, and for quick monitoring of propagation conditions on other bands.

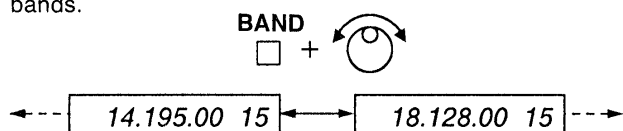

When you do not use the band stacking register, use the [MHz] switch instead of [BAND] to change the band.

The band stacking registers of the IC-728 and IC-729 are slightly different.

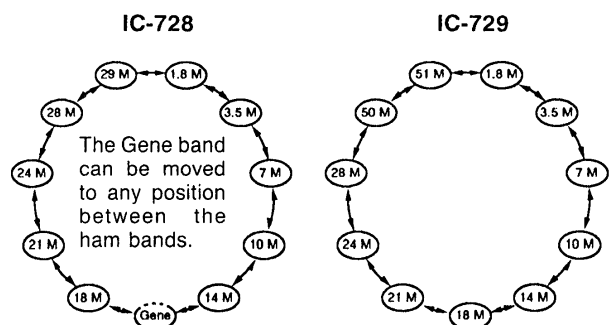

KHz TUNING STEP

The operating frequency can be changed in kHz steps for quick tuning.

- 1) Push [kHz] to display the kHz tuning indicator.
- 2) Rotate the main dial to change the frequency in kHz steps.
- 3) Push [kHz] again to turn OFF the indicator.
- 4) Rotate the main dial for fine tuning if required.

NOTE: When selecting AM or FM mode, the kHz tuning step is automatically selected by the auto tuning step function. When fine tuning is required in AM or FM, push [kHz] to turn OFF the kHz tuning step manually.

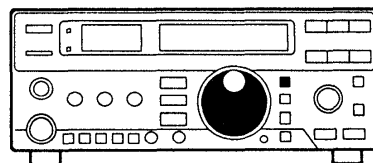

"▼" appears.

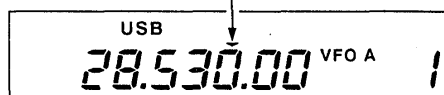

kHz tuning step ON

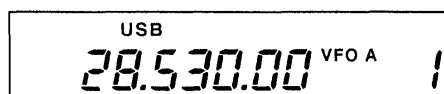

kHz tuning step OFF

CHANGING THE MINIMUM TUNING STEP

The IC-728/729's minimum tuning step default setting is 10 Hz. However, this can be changed to 20 Hz or 50 Hz as follows.

- 1) Push [FUNC].
- 2) While pushing and holding [kHz], rotate the main dial to change the minimum frequency step.
- 3) Release [kHz] after the desired minimum frequency step appears.

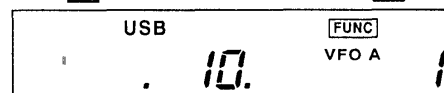
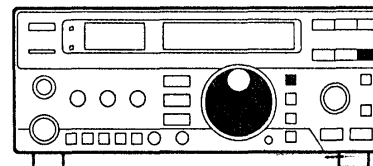

Minimum tuning step: 10 Hz

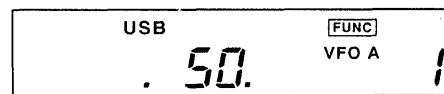

Minimum tuning step: 50 Hz

AUTO TUNING STEP FUNCTION

When selecting AM or FM, the kHz tuning step indicator is automatically selected by the auto tuning step function. This function can be turned ON and OFF for your convenience.

- 1) To turn OFF the function, push [FUNC], then push [AM/FM].
- 2) To turn ON the function again, push [FUNC], then push [AM/FM] again.

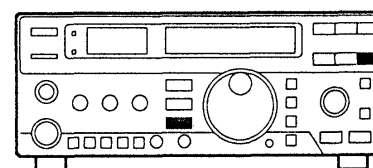

Appears when selecting AM or FM.

**TURNING THE 10 Hz READOUT ON AND OFF**

The 10 Hz readout can be turned ON and OFF. The frequency changes in the minimum tuning step set even if the readout is turned OFF.

- 1) Push [FUNC].
- 2) Push [BAND] to turn OFF the 10 Hz readout.
- 3) To turn the readout back ON, repeat steps 1 and 2.

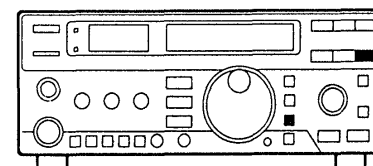

This digit disappears.

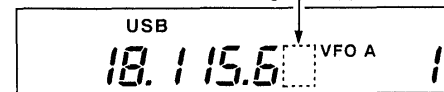

10 Hz readout is OFF.

3 OPERATION

■ Receiving

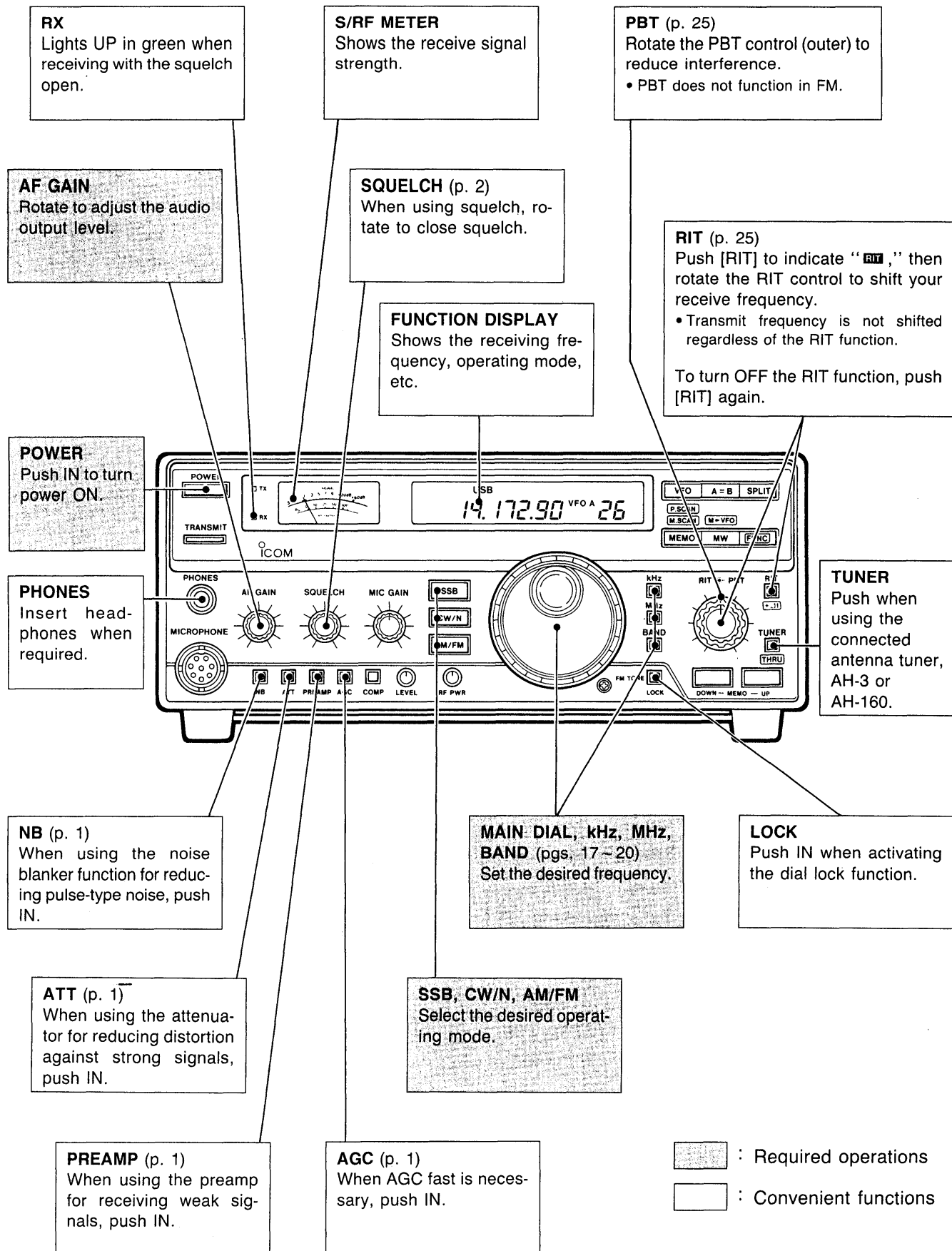

SSB RECEIVING

- 1) Turn power ON with [POWER].
- 2) Select VFO A or VFO B with [VFO].
- 3) Select USB or LSB with [SSB].
- 4) Set the desired frequency with the main dial.
- 5) Adjust the audio output level with [AF GAIN].

Convenient functions for SSB receiving

- NB (Noise Blanker)
- ATT (Attenuator)
- PREAMP (Pre-amplifier)
- AGC (Auto Gain Control)
- PBT (Passband Tuning)
- RIT (Receiver Incremental Tuning)
- LOCK (Dial lock)
- SQUELCH

CW RECEIVING

- 1) Turn power ON with [POWER].
- 2) Select VFO A or VFO B with [VFO].
- 3) Select CW with [CW/N].
- 4) Set the desired frequency with the main dial.
- 5) Adjust the audio output level with [AF GAIN].

Convenient functions for CW receiving

- NB (Noise Blanker)
- ATT (Attenuator)
- PREAMP (Pre-amplifier)
- AGC (Auto Gain Control)
- PBT (Passband Tuning)
- RIT (Receiver Incremental Tuning)
- LOCK (Dial lock)
- SQUELCH
- CW-Narrow mode (An optional CW filter is necessary.)

AM RECEIVING

- 1) Turn power ON with [POWER].
- 2) Select VFO A or VFO B with [VFO].
- 3) Select AM with [AM/FM].
- 4) Set the desired frequency with the main dial.
- 5) Adjust the audio output level with [AF GAIN].

Convenient functions for AM receiving

- ATT (Attenuator)
- PREAMP (Pre-amplifier)
- AGC (Auto Gain Control)
- RIT (Receiver Incremental Tuning)
- LOCK (Dial lock)
- SQUELCH
- AUTO TUNING STEP (p. 20)

FM RECEIVING (The IC-728 requires the UI-7 AM/FM unit.)

- 1) Turn power ON with [POWER].
- 2) Select VFO A or VFO B with [VFO].
- 3) Select FM with [AM/FM].
- 4) Set the desired frequency with the main dial.
- 5) Adjust the audio output level with [AF GAIN].

Convenient functions for FM receiving

- SQUELCH
- ATT (Attenuator)
- PREAMP (Pre-amplifier)
- RIT (Receiver Incremental Tuning)
- LOCK (Dial lock)
- AUTO TUNING STEP (p. 20)

RTTY RECEIVING (External equipment is necessary.)

- 1) Turn power ON with [POWER].
- 2) Select VFO A or VFO B with [VFO].
- 3) Select LSB with [SSB].
- 4) Set the desired frequency with the main dial.
- 5) Adjust the audio output level with [AF GAIN].

Operating notes for RTTY receiving

- RTTY operating frequency differs from the displayed frequency. Refer to the following formula.

[Your RX freq.] = [Displayed freq.] - 2125 Hz
(when the frequencies of your RTTY demodulator are mark = 2125 Hz and space = 2295 Hz.)

3 OPERATION

■ Transmitting

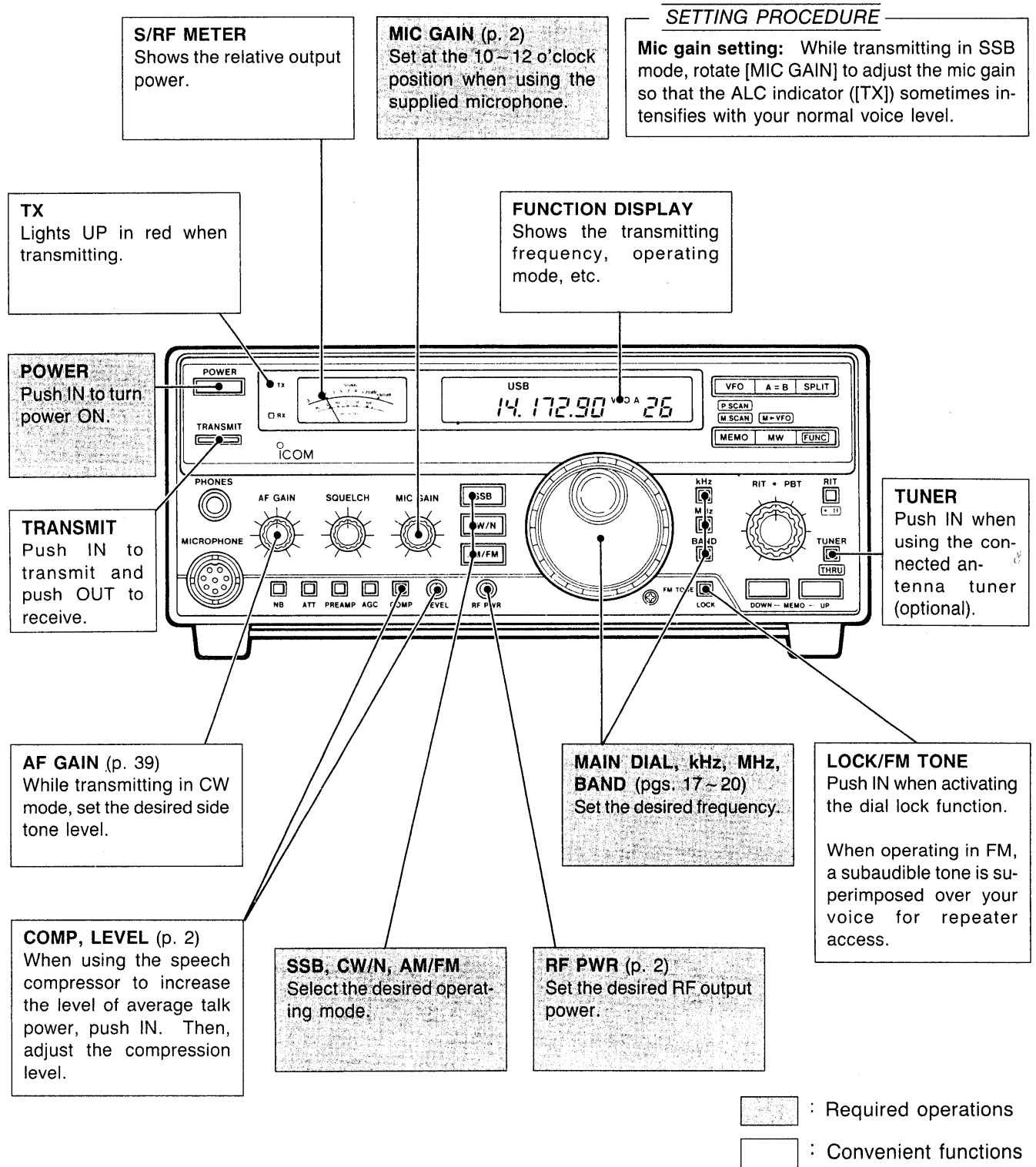

S/RF METER
Shows the relative output power.

MIC GAIN (p. 2)
Set at the 10~12 o'clock position when using the supplied microphone.

SETTING PROCEDURE
Mic gain setting: While transmitting in SSB mode, rotate [MIC GAIN] to adjust the mic gain so that the ALC indicator ([TX]) sometimes intensifies with your normal voice level.

TX
Lights UP in red when transmitting.

FUNCTION DISPLAY
Shows the transmitting frequency, operating mode, etc.

POWER
Push IN to turn power ON.

TRANSMIT
Push IN to transmit and push OUT to receive.

TUNER
Push IN when using the connected antenna tuner (optional).

AF GAIN (p. 39)
While transmitting in CW mode, set the desired side tone level.

MAIN DIAL, kHz, MHz, BAND (pgs. 17~20)
Set the desired frequency.

LOCK/FM TONE
Push IN when activating the dial lock function.

When operating in FM, a subaudible tone is superimposed over your voice for repeater access.

COMP, LEVEL (p. 2)
When using the speech compressor to increase the level of average talk power, push IN. Then, adjust the compression level.

SSB, CW/N, AM/FM
Select the desired operating mode.

RF PWR (p. 2)
Set the desired RF output power.

▨ : Required operations
□ : Convenient functions

SSB TRANSMITTING

- 1) Set for SSB receiving.
- 2) Set the frequency in your allowed frequency range for SSB transmitting.
- 3) Set the desired RF output power with [RF PWR].
- 4) Push and hold the PTT switch on the microphone and speak into the microphone.

Operating notes for SSB transmitting

- [MIC GAIN] should be set correctly. When using a non-lcom microphone, set [MIC GAIN] referring to "SETTING PROCEDURE" described on the left page.

Convenient functions for SSB transmitting

- COMP (Speech compressor)

CW TRANSMITTING (An external CW keyer is necessary.)

- 1) Set for CW receiving.
- 2) Set the frequency in your allowed frequency range for CW transmitting.
- 3) Set the desired RF output power with [RF PWR].
- 4) Push the key down and start CW transmitting.

Operating notes for CW transmitting

- The break-in function automatically starts transmitting when the key is down, and then returns to receive. If you want to switch transmitting/receiving manually, turn the break-in function OFF with the [BK IN] switch on the rear panel.

Convenient functions for CW transmitting

- Break-in delay time adjustment (by the [DELAY] control on the rear panel)
- CW side tone level preset (See p. 39 for details.)

AM TRANSMITTING (The IC-728 requires the UI-7 unit.)

- 1) Set for AM receiving.
- 2) Set the frequency in your allowed frequency range for AM transmitting.
- 3) Set the desired RF output power with [RF PWR].
- 4) Push and hold the PTT switch on the microphone and speak into the microphone.

Operating notes for AM transmitting

- [MIC GAIN] should be set correctly. When using a non-lcom microphone, set [MIC GAIN] by monitoring another receiver.

Convenient functions for AM transmitting

- COMP (Speech compressor)

FM TRANSMITTING (The IC-728 requires the UI-7 unit.)

- 1) Set for FM receiving.
- 2) Set the frequency in your allowed frequency range for FM transmitting.
- 3) Set the desired RF output power with [RF PWR].
- 4) Push and hold the PTT switch on the microphone and speak into the microphone.

Operating notes for FM transmitting

- [MIC GAIN] should be set correctly. When using a non-lcom microphone, set [MIC GAIN] by monitoring another receiver.

Convenient functions for FM transmitting

- COMP (Speech compressor)
- FM TONE (Subaudible tone)

RTTY TRANSMITTING (External equipment is necessary.)

- 1) Set for RTTY receiving. (LSB should be selected.)
- 2) Set the frequency in your allowed frequency range for RTTY transmitting.
- 3) Set the desired RF output power with [RF PWR].
- 4) Push [TRANSMIT] IN or send a TX control signal; then, start transmitting your RTTY signal.

Operating notes for RTTY transmitting

- RTTY operating frequency differs from the displayed frequency. Refer to the following formula.

[Your TX freq.] = [Displayed freq.] - 2125 Hz
(when the oscillated frequencies of your AFSK generator are mark = 2125 Hz and space = 2295 Hz.)

Frequency setting example for RTTY transmitting

When operating at 14.090 MHz: Set "LSB 14.0921" and input 2125 Hz (mark) and 2295 Hz (space) AFSK signal.

3 OPERATION

■ RIT and “+ Δ f”

• RIT function

FUNCTION

The **RIT function** shifts the receive frequency up to ± 1.2 kHz in 10 Hz steps without moving the transmit frequency.

This is useful for fine tuning stations which transmit using an off frequency or for compensating for frequency drift.

- 1) Push the [RIT] switch.



- 2) Rotate the RIT control.

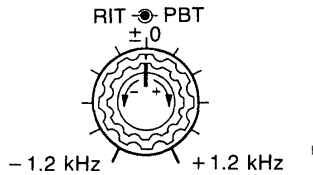

- 3) To cancel the RIT function, push [RIT] again.

- “RIT” disappears.

• “+ Δ f” function

FUNCTION

The **+ Δ f function** adds the RIT shift frequency to the displayed frequency.

This is useful for transmitting on the real receiving frequency shifted by the RIT.

- 1) Set the RIT shift.

- Proceed with steps 1 and 2 described at left.



- 2) Push [FUNC], then push [RIT].

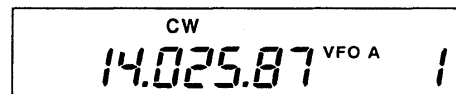

Rit shift frequency is added.

This function is available only when “RIT” is indicated.

■ PBT operation

The PBT function electronically narrows the IF passband width to reduce interference.

The PBT control should usually be left in the center position when there is no interference.

NOTE: When PBT is used, the audio tone may be changed.

PBT OPERATION EXAMPLE

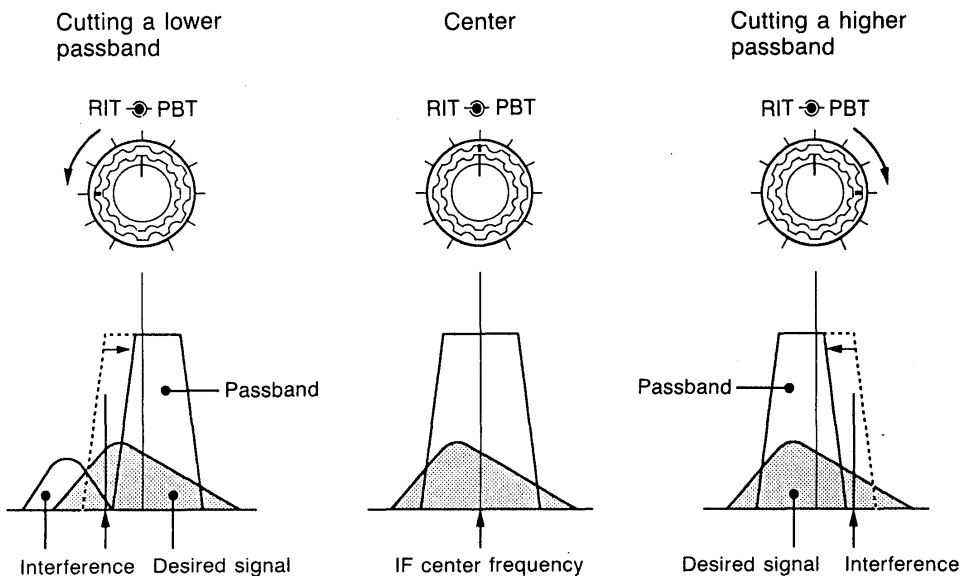

■ Split frequency operation

Split frequency operation allows you to transmit and receive on two different frequencies.

The split frequency operation is basically performed using 2 frequencies on VFO A and VFO B.

Following is a basic example for setting 21.250 MHz for receiving and 21.360 MHz for transmitting.

- 1) Select VFO A; then, set 21.250 MHz (USB) in VFO A.



- 2) Select VFO B; then, set 21.360 MHz (USB) in VFO B.

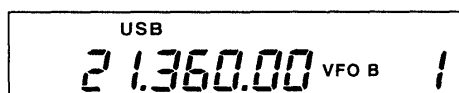

- 3) Select VFO A; then, push [SPLIT].

- "SPLIT" appears.

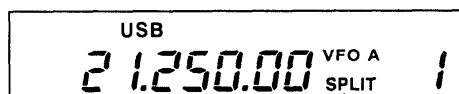

"SPLIT" appears.

Now you can receive on 21.250 MHz and transmit on 21.360 MHz.

- The function display shows 21.250 while receiving and 21.360 while transmitting.

To change the transmit and receive frequencies, push [VFO] to exchange VFOs.

NOTE: The IC-728/729 has 2 split memory channels (memory channel 23 and 24) which store 2 frequencies for split frequency operation. See p. 32 for details.

PRACTICAL EXAMPLE

When you find a DX station on 14.195 MHz/USB and the station says "UP 10 kHz" for our calling frequency;

- 1) Push [A = B].
 - The rear VFO frequency and operating mode is equalized to the displayed VFO frequency and mode.
- 2) Rotate the main dial to set the displayed frequency to 14.205 MHz.
 - $14.195 \text{ MHz} + 10 \text{ kHz} = 14.205 \text{ MHz}$.
- 3) Push [VFO] to exchange the VFOs.
 - The transmit frequency is set to 14.205 MHz and the receive frequency is set to 14.195 MHz.
- 4) Push [SPLIT] to select split frequency operation.
 - "SPLIT" appears.
- 5) Push and hold the PTT switch and call after the DX station is standingby.

■ Cross mode operation

Cross mode operation allows you to transmit and receive on two different operating modes.

Set the same frequency but different modes in VFO A and VFO B.

While receiving

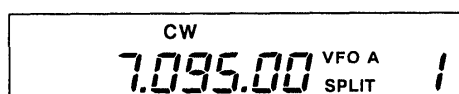

While transmitting

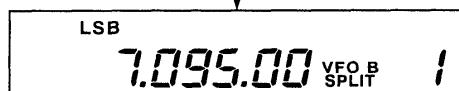

- 1) Set the operating frequency on VFO A or VFO B.
- 2) Push [A = B] to equalize rear VFO frequency to the displayed VFO frequency.
- 3) Select the mode for transmitting on the displayed VFO.
- 4) Push [VFO] to change the VFO; then, select the mode for receiving on the newly displayed VFO.
- 5) Push [SPLIT] to turn the split function ON.

■ Optional antenna tuner operation

AH-3 HF AUTOMATIC ANTENNA TUNER

The AH-3 matches the IC-728/729 to an antenna more than 3 m/10 ft long (3.5 MHz and above) or more than 12 m/40 ft long (1.8 MHz and above).

- See p. 13 for the transceiver and AH-3 connection.
- See the AH-3 instruction manual for AH-3 installation and antenna connection details.

AH-3 setting example:

For mobile operation

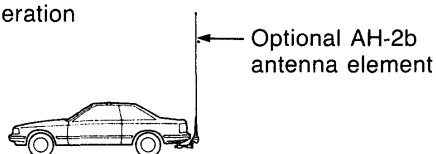

For outdoor operation

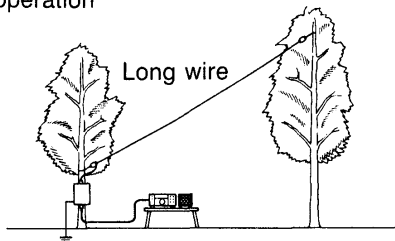

WARNING: HIGH VOLTAGE!
NEVER touch the antenna element while tuning or transmitting.

CAUTIONS:

BE SURE to push the tuner selection switch OUT on the transceiver rear panel before tuning with the AH-3. If the switch has been pushed IN, the transceiver or the AH-3 may be damaged.

- When the switch is pushed OUT, "AH-3" appears for 1 sec. on the function display as follows:

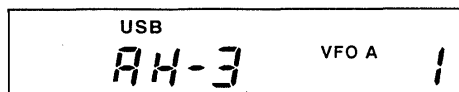

NEVER operate the AH-3 without an antenna wire. The tuner and transceiver will be damaged.

NEVER operate the AH-3 when it is ungrounded.

The AH-3 cannot be used for 50 MHz. **DO NOT** connect the AH-3 to the 50 MHz antenna connector of the IC-729.

Transmitting before tuning or transmitting while the "THRU" indicator lights may damage the transmitter circuit.

AH-3 operation

Re-tuning is necessary when you change the operating frequency.

- 1) Turn the transceiver power ON.
 - "TUNE" appears.
- 2) Set the desired frequency in a ham band.
 - The AH-3 will not operate on frequencies out of ham bands.
- 3) Push [TUNER].
 - "TUNE" blinks and "CW" appears while tuning.

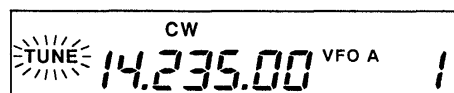
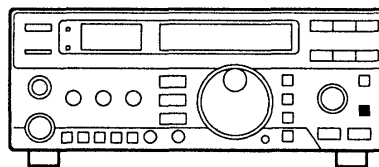

- "TUNE" lights constantly when the tuning is complete.

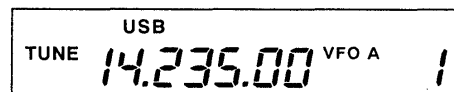

- "THRU" appears when the AH-3 cannot tune the connected antenna wire.

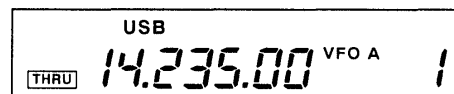

- When "THRU" appears, the AH-3 is bypassed and the antenna wire is connected to the antenna connector on the transceiver directly.

To bypass the AH-3 manually, push [FUNC] then push [TUNER].

- "THRU" appears.

Tuning is necessary for each frequency. **Be sure** to re-tune the antenna before transmitting when you change the operating frequency, even a little bit.

AT-160 HF AUTOMATIC ANTENNA TUNER

The AT-160 matches the IC-728/729 to the antenna automatically. The AT-160 has memories for auto-preset. No preset operation is necessary.

When you change the operating band, the AT-160 automatically presets for the band. Then when you start transmitting, the AT-160 tunes the antenna exactly. No re-tuning is necessary.

The AT-160 power is supplied from the transceiver and power ON/OFF is relayed to the transceiver power switch.

CAUTIONS:

BE SURE to push the tuner selection switch IN on the transceiver rear panel before tuning with the AT-160. If the switch has been pushed OUT, the transceiver and the AT-160 may be damaged.

- When the switch is pushed IN, "AT-160" appears for 1 sec. on the function display as follows:

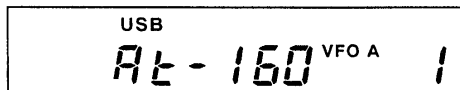

NEVER operate the AT-160 without an antenna. The tuner and transceiver will be damaged.

The AT-160 cannot be used for 50 MHz. **DO NOT** connect the AT-160 to the 50 MHz antenna connector of the IC-729.

AT-160 operation

No re-tuning is necessary when you change the operating frequency.

- 1) Turn the transceiver power ON.
 - The AT-160 power is turned ON and "THRU" appears.

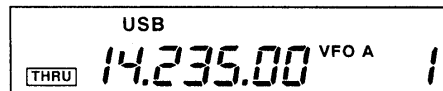

- 2) Push [TUNER] to activate the AT-160.
 - The AT-160 presets the antenna for the displayed band.
 - "TUNE" appears.

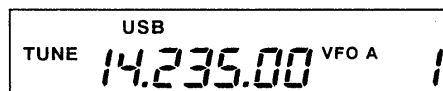
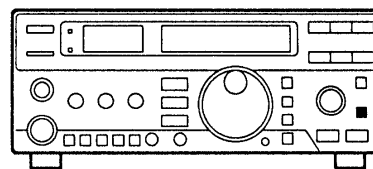

When you start transmitting, the AT-160 automatically tunes the antenna.

To tune the antenna manually, push and hold [TUNER] for 1 sec.

- "TUNE" blinks and "CW" appears while tuning.

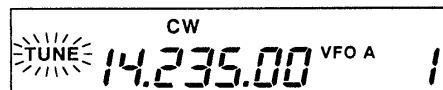

To bypass the AT-160 manually, push [FUNC] then push [TUNER].

- "THRU" appears.

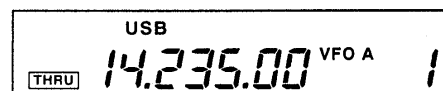

NOTE: "TUNE" blinks irregularly during transmission, if the AT-160 cannot tune the connected antenna. In this case, it is necessary to push and hold [TUNER] for 1 sec. to re-tune the antenna.

IC-AT500 HF 500 W AUTOMATIC ANTENNA TUNER

AT-150 HF AUTOMATIC ANTENNA TUNER

See the instruction manual included with each antenna tuner. Either position of the tuner selection switch is acceptable for these tuners.

Memory channels

The IC-728/729 has 26 memory channels. The memory mode is very useful for quickly changing to often used frequencies.

Memory channels 1 ~ 22 can be programmed with one frequency and one mode in each memory channel. Memory channels 23 ~ 26 also have the special functions described in the diagram at right:

MEMORY CHANNEL	CAPABILITY
Normal memory channels MEMO 1 ~ MEMO 22	One frequency and one mode in each memory channel.
Split memory channels MEMO 23, MEMO 24	Independent transmit and receive frequencies and operating modes in each memory channel for split operation. (p. 32)
Scan edge memory channels MEMO 25, MEMO 26	One frequency and one mode in each memory channel as scan edges for programmed scan. (p. 33)

Memory channel selection

- 1) Push [MEMO] to select the memory mode.
- 2) Push [UP] or [DOWN] on the front panel several times to select the desired memory channel.
 - [UP] and [DN] on the microphone also select memory channels.
- 3) To return to the VFO mode, push [MEMO] again.

NOTE: When the dial lock function has been activated ([LOCK] has been pushed IN), selected mode memory channel selection can be used. See the box below.

[EXAMPLE]: Selecting memory channel 17.

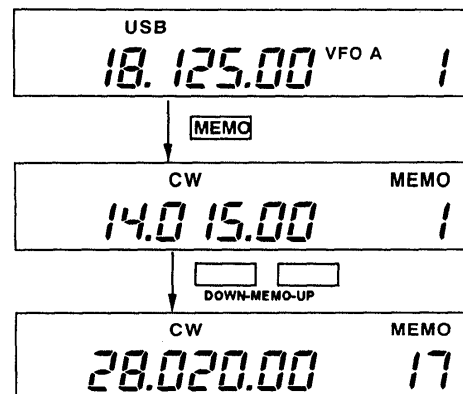

SELECTED MODE MEMORY CHANNEL SELECTION

Only memory channels programmed with the same operating mode can be selected for quick memory channel selection.

- 1) Push [MEMO] to select the memory mode.
- 2) Select the desired operating mode.
- 3) Push [LOCK] IN.
- 4) Push [UP] or [DOWN] to select the desired memory channel.
 - When no memory channel has been programmed with the selected operating mode, the operating mode returns to the previous one automatically.
- 5) Push [LOCK] OUT to turn this function OFF.

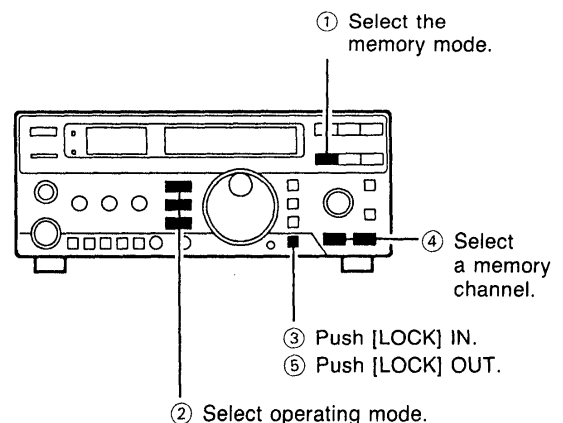

■ Memory channel programming

Memory channel programming can be performed either in the VFO mode or in the memory mode.

• Programming in the VFO mode

- 1) Set the desired frequency and operating mode in the VFO mode.
- 2) Push [UP] or [DOWN] several times to select the desired memory channel to be programmed.
 - To confirm the memory channel contents, push [MEMO]; then push [MEMO] again to return to the VFO mode.
- 3) Push [MW] to program the displayed frequency and operating mode into the memory channel.

To check the programmed contents, push [MEMO] to select the memory mode.

[EXAMPLE]: Programming 7.088 MHz/LSB into memory channel 12.

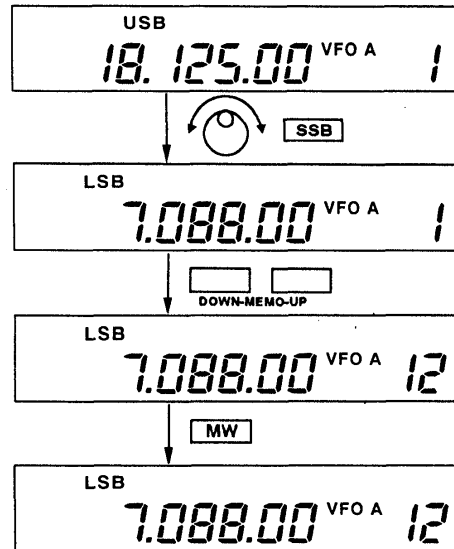

• Programming in the memory mode

- 1) Select the desired memory channel to be programmed with [UP] or [DOWN] in the memory mode.
- 2) Set the desired frequency and operating mode in the memory mode.
- 3) Push [MW] to program the displayed frequency and operating mode into the memory channel.

[EXAMPLE]: Programming 21.280 MHz/USB into memory channel 18.

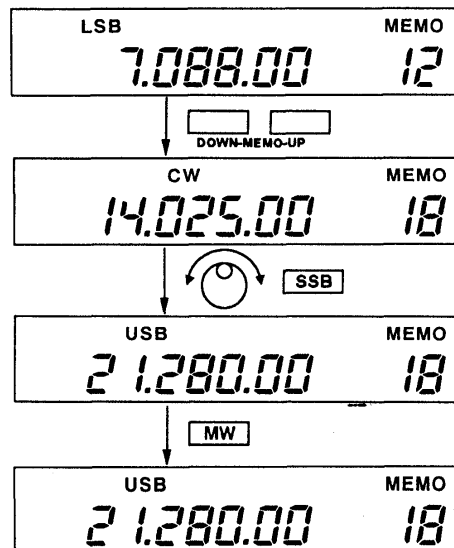

PRACTICAL EXAMPLE

When you find a station on 21.015 MHz/CW in the VFO mode, and you want to keep watching for other stations.

- You have decided to use memory channels 11 ~ 15 for storing frequencies temporarily.

- 1) Push [UP] or [DOWN] several times to select memory channel 11 in the VFO mode.

- 2) Push [MW] to store 21.015 MHz/CW into memory channel 11.

- 3) Rotate the main dial to continue watching.

- 4) Push [MEMO] to quickly select the stored frequency.

- 5) To return to the VFO mode, push [MEMO] again.

4 MEMORY CHANNELS

■ Frequency transferring

The frequency and operating mode in the memory mode can be transferred to the VFO mode.

The frequency transferring can be performed in either the VFO mode or in the memory mode.

• Transferring in the VFO mode

This way is useful for transferring the programmed contents to VFO.

- 1) Select VFO A or VFO B with [VFO].
- 2) Select a memory channel with [UP] or [DOWN].
 - To confirm the memory channel contents, push [MEMO]; then, push [MEMO] again to return to the VFO mode.
- 3) Push [FUNC]; then, push [MW] to transfer the frequency and operating mode.
 - Transferred frequency and operating mode appears on the display.

TRANSFERRING EXAMPLE IN THE VFO MODE

Operating frequency : 21.320 MHz/USB (VFO A)
Contents of MEMO 18 : 14.020 MHz/CW

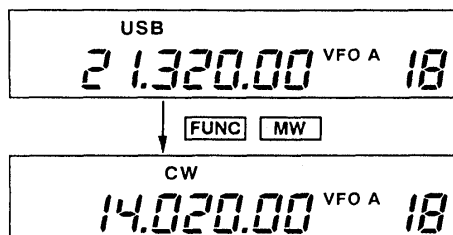

• Transferring in the memory mode

This is useful for transferring frequency and operating mode while operating in the memory mode.

NOTE: When you have changed the frequency or operating mode in the selected memory channel;
- **Displayed** frequency and mode are transferred.
- **Programmed** frequency and mode are not transferred, but they remain in the memory channel.

- 1) Select a memory channel with [UP] or [DOWN].
 - And, set the frequency or operating mode if required.
- 2) Push [FUNC]; then, push [MW] to transfer the frequency and operating mode.
 - The memory contents are transferred to the VFO previously used.
- 3) To return to the VFO mode, push [VFO].

TRANSFERRING EXAMPLE IN THE MEMORY MODE

Operating frequency : 14.028 MHz/CW (MEMO 19)
Previously used VFO : VFO A

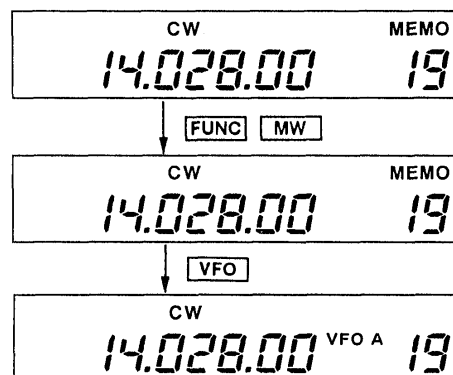

■ Programming split memory channels (for accessing a repeater)

Memory channels 23 and 24 are split memory channels and can be programmed for both transmit and receive frequencies and operating modes.

These memory channels are especially useful for repeater operation.

• Split memory channel selection

Select memory channel 23 and 24 with [UP] or [DOWN] in the memory mode.

- "SPLIT" blinks, then disappears if only 1 frequency has been programmed in that channel.
- "SPLIT" blinks, then lights if 2 frequencies have been programmed in that channel.



• Split memory channel programming

Following is a programming example of 29.680 MHz/FM for receiving and 29.580 MHz/FM for transmitting in memory channel 23.

- An optional UI-7 is required for FM operation with the IC-728.

- 1) Set 29.680 MHz (RX freq.) and FM in VFO A.



- 2) Set 29.580 MHz (TX freq.) and FM in VFO B.



- 3) Select memory channel 23 with [UP] or [DOWN].

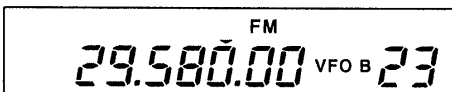

- 4) Select VFO A with [VFO].

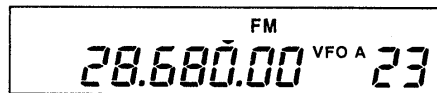

- 5) Push [SPLIT].

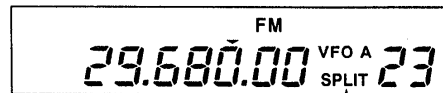

"SPLIT" appears.

- 6) Push [MW] to program the frequencies.

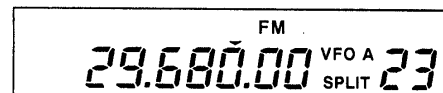

- 7) Push [MEMO] to select the memory mode.

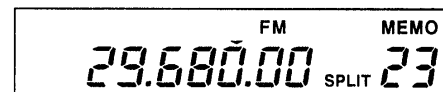

• Split memory channel operation

When memory channel 23 or 24 is selected and the memory channel has been programmed with 2 frequencies, split frequency operation is automatically selected.

- 1) Transmit.
 - Transmit frequency appears while transmitting.
- 2) Return to receive.
 - Receive frequency appears while receiving.

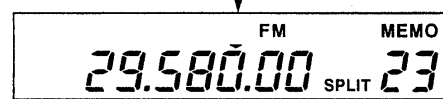
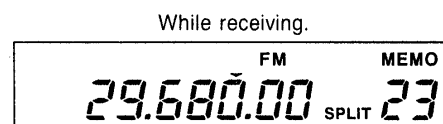

To turn the split frequency operation OFF, push [SPLIT].

- "SPLIT" disappears.
- Simplex operation is selected with the receive frequency programmed in the selected split memory channel.

For accessing a repeater which needs a subaudible tone, push [LOCK] IN to turn the tone encoder ON.
 • An optional UT-30 is necessary to generate a tone.

■ Scan types

The IC-728/729 has 3 types of scan functions which provide tremendous scanning versatility at the touch of a few switches.

Select the scan which matches your operating needs.

MEMORY SCAN

Repeatedly scans all memory channels.

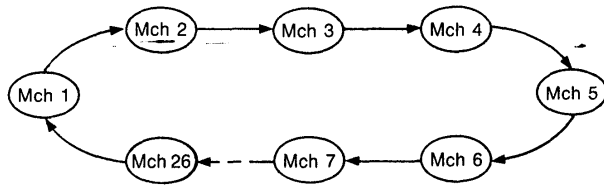

This scan operates in the memory mode.

PROGRAMMED SCAN

Repeatedly scans between two scan edge frequencies (memory channels 25 and 26).

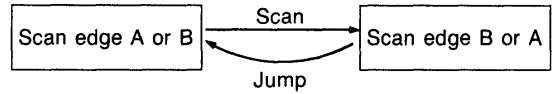

This scan operates in the VFO mode.

SELECTED MODE MEMORY SCAN

Repeatedly scans all memory channels with the same selected operating mode.

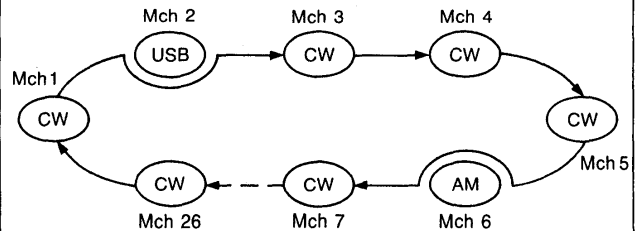

This scan operates in the memory mode.

■ Pre-operation

Program the memory channels before operating a scan as follows:

SCAN TYPE	REQUIRED PRE-OPERATION
PROGRAMMED SCAN	Program scan edge frequencies* into memory channels 25 and 26.
MEMORY SCAN	Program desired scan frequencies into memory channels.
SELECTED MODE MEMORY SCAN	Program desired scan frequencies and operating mode into 2 or more memory channels.

* For the IC-729, program frequencies in the same range, 0.03 ~ 33 MHz (HF) or 46.2 ~ 61.1 MHz (50 MHz), into memory channels 25 and 26.

Programmed scan does not start if 2 scan edge frequencies have been programmed beyond the range.

Before starting a scan, open or close the squelch as desired.

SCAN STARTS WITH	SCAN CONDITION
SQUELCH OPEN	The scan continues until it is stopped, and does not pause even if it detects signals.
SQUELCH CLOSED	The scan pauses for a set time when it detects signals, then resumes. The set time is 10 sec. for normal signals and 3 sec. for single tones.

See p. 39 for advanced scan functions.

■ Programmed scan operation

Programmed scan can be started in either the VFO mode or the memory mode.

- 1) Select the desired operating mode.
 - The operating mode can also be changed while scanning.
- 2) Set [SQUELCH] open or closed.
 - See page at left for scan condition.
- 3) Push [FUNC]; then, push [VFO] to start the scan.
 - The VFO mode is automatically selected.
- 4) When the scan detects a signal, the scan pauses or ignores it depending on the squelch condition.
- 5) To cancel the scan, rotate the main dial, or push [VFO], [A = B], [MEMO] or [MW].

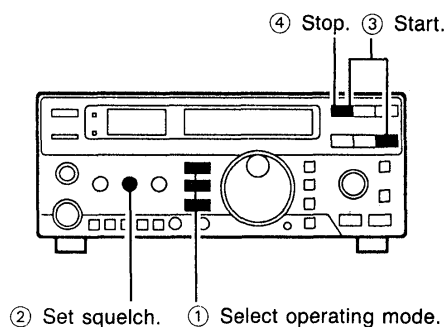

■ Memory scan operation

Memory scan can be started in either the VFO mode or the memory mode.

- 1) Set [SQUELCH] open or closed.
 - See page at left for scan condition.
- 2) Push [FUNC]; then, push [MEMO] to start the scan.
 - The memory mode is automatically selected.
- 3) When the scan detects a signal, the scan pauses or ignores it depending on the squelch condition.
- 4) To cancel the scan, rotate the main dial, or push [VFO], [A = B], [MEMO] or [MW].

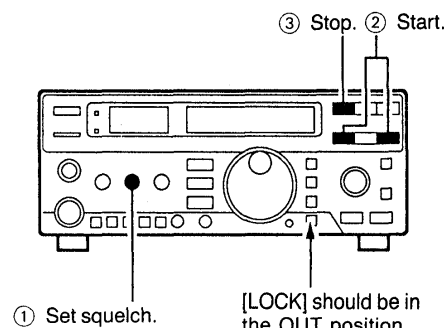

To change the scan type to selected mode memory scan while scanning, push [LOCK] IN.

■ Selected mode memory scan operation

Selected mode memory scan can be started in either the VFO mode or the memory mode.

- 1) Set [SQUELCH] open or closed.
 - See page at left for scan condition.
- 2) Select the desired operating mode; then, push [LOCK] IN.
- 3) Push [FUNC]; then, push [MEMO] to start the scan.
 - The memory mode is automatically selected.
- 4) When the scan detects a signal, the scan pauses or ignores it depending on the squelch condition.
- 5) To cancel the scan, rotate the main dial, or push [VFO], [A = B], [MEMO] or [MW].

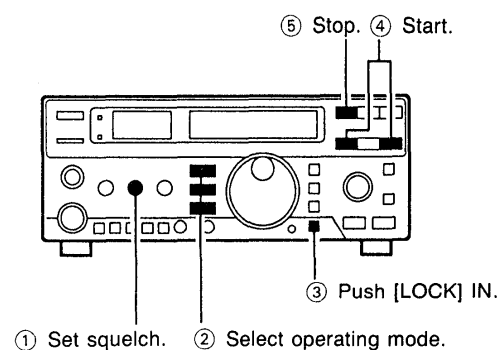

The operating mode can be changed while scanning.
 •When a mode is not memorized in 2 or more selected memory channels, the scan is canceled.

6

MAINTENANCE AND ADJUSTMENT

Disassembling the transceiver

Follow the transceiver disassembly procedures shown here when you want to install an optional unit, adjust the internal units, or to replace an internal fuse, etc.

CAUTION: DISCONNECT the DC power cable from the transceiver before performing any work on the transceiver.

A REMOVING COVERS

To remove top and bottom covers, unscrew the 16 screws as shown in the figure below.

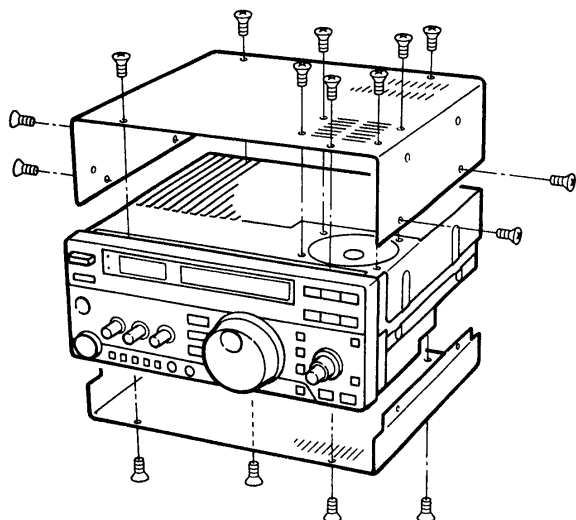

B PREPARING FOR THE PA UNIT REMOVAL-1

Unscrew the 4 screws as shown in the figure below.

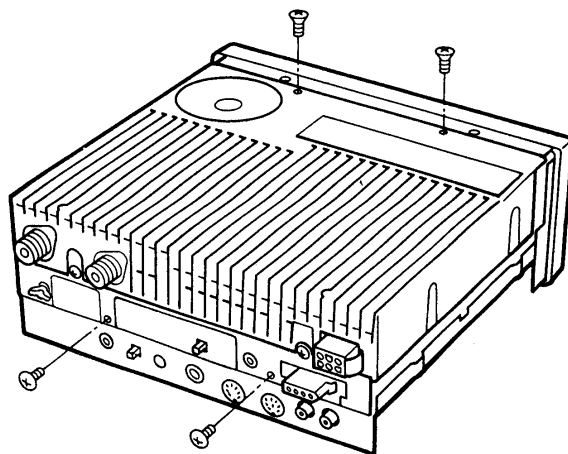

C PREPARING FOR THE PA UNIT REMOVAL-2 (FOR THE IC-728)

Unplug the 2 coaxial cables from J11 and J12; then, unplug the 3-pin connector from J13 as shown in the figure below.

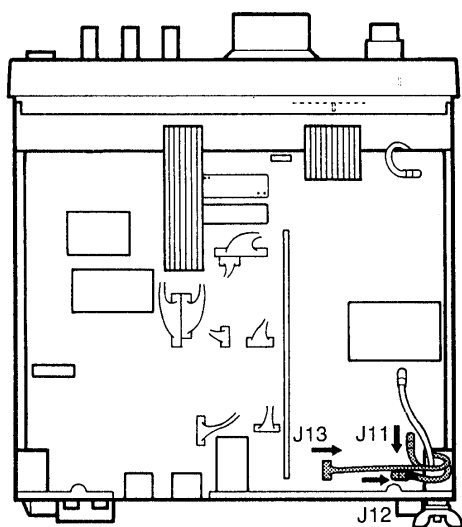

(FOR THE IC-729)

Unplug the 3 coaxial cables from J11, J12 and J31; then, unplug the 3-pin connector from J13 as shown in the figure below.

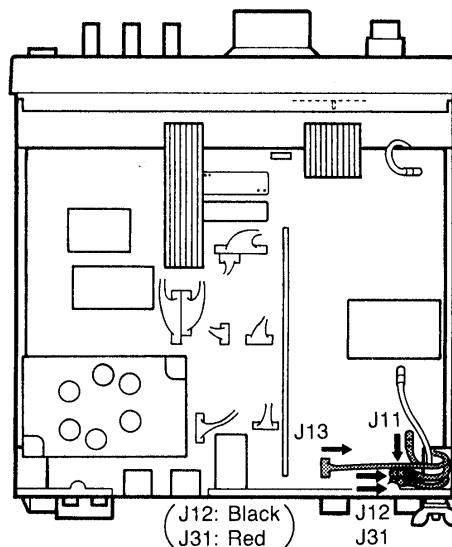

D REMOVING THE PA UNIT

- 1) Disconnect the 7-pin connector from J7 on the PLL unit as shown in the figure below.
- 2) Slide the tuner control socket up and remove it from the holder.

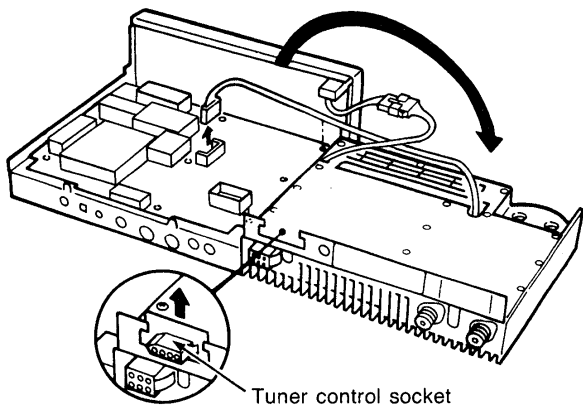

E OPENING THE PA UNIT

- 1) Remove the PA unit as shown in the box at left.
- 2) Unscrew the 19 screws to remove the PA unit shield cover as shown in the figure below.

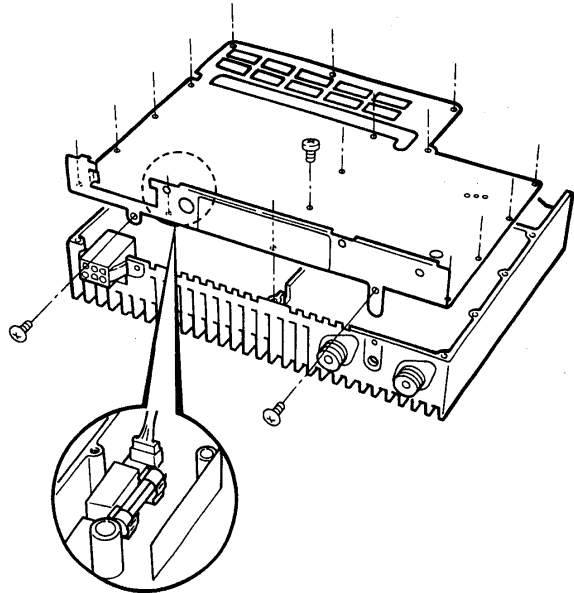

**F REMOVING THE PLL UNIT
(FOR THE IC-728)**

To remove the PLL unit, unplug the 2 coaxial cables from J4 and J5 on the main unit as shown in the figure below.

- See pgs. 45~46 for plug connection information.

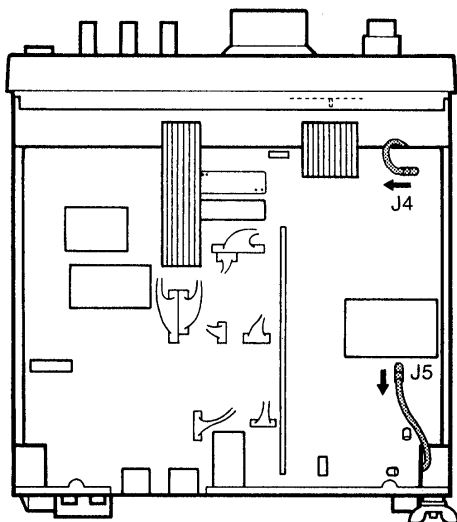

(FOR THE IC-729)

To remove the PLL unit, unplug the 2 coaxial cables from J4 and J5 on the main unit as shown in the figure below.

- See pgs. 47~48 for plug connection information.

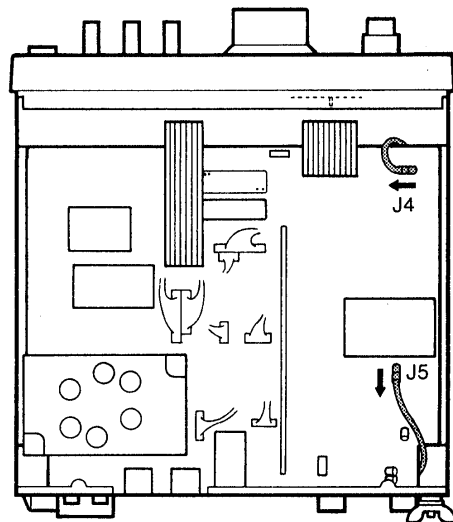

6 MAINTENANCE AND ADJUSTMENT

■ Fuse replacement

If a fuse blows or the transceiver stops functioning, try to find the source of the problem, then replace the damaged fuse with a new, rated fuse.

CAUTION: DISCONNECT the DC power cable from the transceiver when changing the fuse.

The IC-728/729 has 2 types of fuses installed for transceiver protection.

- DC power cable fuses 20 A
- Circuitry fuse F. G. M. B. 125 V, 4 A

DC POWER CABLE FUSES REPLACEMENT

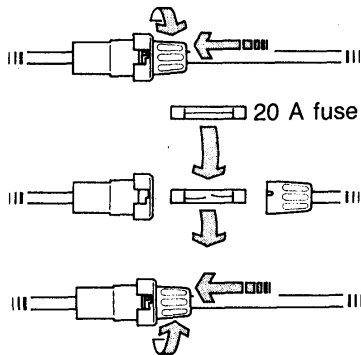

CIRCUITRY FUSE REPLACEMENT

This fuse is installed in the PA UNIT. 12 V of DC power are applied to the circuitry in the IC-728/729 through the DC line fuse and the PA unit.

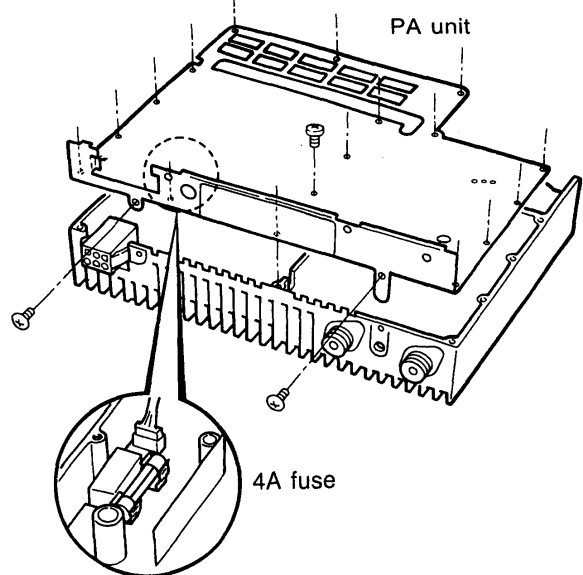

■ Resetting the CPU

The function display may occasionally display erroneous information (e.g., when first applying power). This may be caused externally by static electricity or other factors.

If this problem occurs, turn the power OFF. Wait a few seconds, then turn power ON again. If this problem continues, follow this procedure:

CAUTION: CPU resetting CLEARS all contents in memory channels, and returns programmed values to default settings.

- 1) Turn power OFF.
- 2) While pushing and holding [MW] and [FUNC], turn power ON.
 - ALL indications are displayed for a couple of seconds, then 14.10000 MHz/USB is displayed.

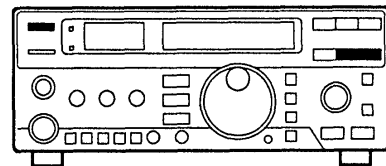

- 3) Release switches.
 - The CPU is now reset.

■ CPU backup battery

The IC-728/729 has a lithium backup battery for retaining memory information.

The usual life of the backup battery is approximately 5 years. When the battery is exhausted, the transceiver transmits and receives normally but cannot retain memory information.

CAUTION: The backup battery should be replaced by an authorized Icom Dealer or Service Center.

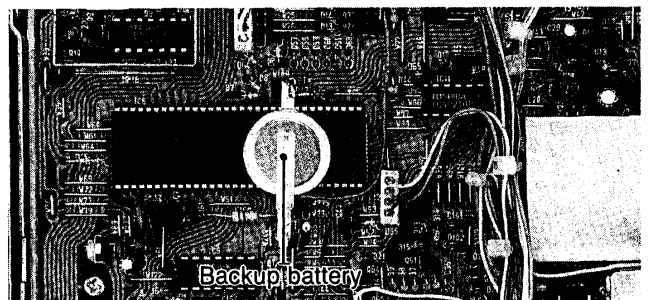

■ Frequency calibration (approximate)

A very accurate frequency counter is required to calibrate the frequency of the IC-728/729. However, a rough check may be performed by receiving radio station WWV, or other standard frequency signals.

The calibration can be performed in each operating mode, and it is unnecessary to calibrate in each band. The calibration range is ± 1.26 kHz in 10 Hz step.

CAUTION: Your IC-728/729 has been thoroughly adjusted and checked at the factory before being shipped. You should not calibrate the frequency, except for special reasons.

- 1) Set the displayed frequency to 10.00000 MHz/USB or 15.00000 MHz/USB to receive a standard frequency station.
 - Other standard frequencies can also be used.
- 2) Turn the transceiver power OFF.
- 3) While pushing and holding [FUNC] and [RIT], turn power ON.
- 4) Release [FUNC] and [RIT].
 - "RIT" blinks, and calibration mode is selected.
- 5) Rotate the [RIT] control for a zero beat.

- 6) Push [MW] to memorize the USB calibration value.
- 7) Push [SSB] to select LSB.
- 8) Rotate the [RIT] control for a zero beat.
- 9) Push [MW] to memorize the LSB calibration value.
- 10) Push [CW/N] to select CW.
- 11) Rotate the [RIT] control for a zero beat.
- 12) Push [MW] to memorize the CW calibration value.
- 13) Push [RIT] to exit the calibration mode.

- Calibration for AM or FM can also be performed, but an accurate frequency counter is necessary.

- The calibration value is effective after exit from the calibration mode.

- To clear the calibration value, push [FUNC] then push [MW] in the calibration mode.

■ Main dial brake adjustment

The tension of the main dial may be adjusted to suit your preference.

The brake adjustment screw is located on the right side of the main dial. See the figure at right.

Turn the brake adjustment screw clockwise or counterclockwise to a comfortable tension level while turning the main dial continuously and evenly in one direction.

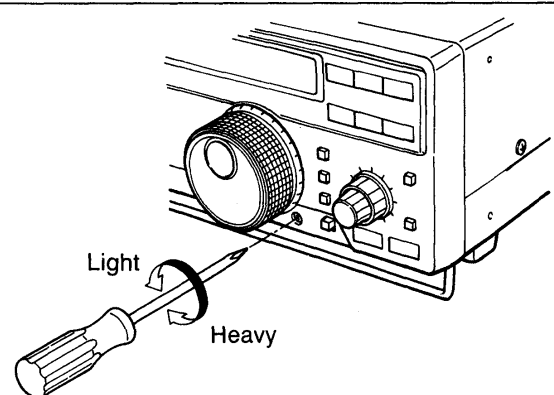

■ Cleaning

If the transceiver becomes dusty or dirty, wipe it clean with a dry, soft cloth.

AVOID the use of strong chemical agents such as thinner, benzine or alcohol to clean the cabinet, as they may damage the transceiver's surfaces.

6 MAINTENANCE AND ADJUSTMENT

■ CW side tone level preset

CW side tone output can be controlled by [AF GAIN]. If you want to change the basic CW side tone level, perform the procedure described at right.

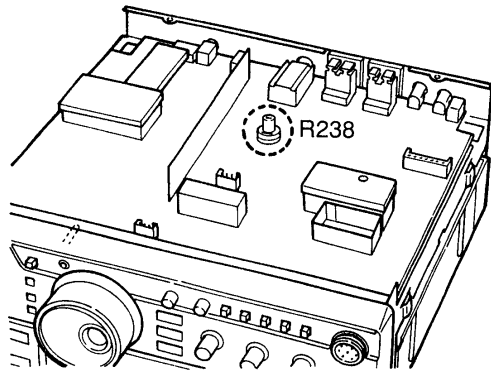

- 1) Remove the top and bottom covers.
- 2) Adjust the R238 as shown in the diagram at left.
- 3) Replace the top and bottom covers.

■ Advanced scan functions

By installing silicon diodes (sold separately) in the positions indicated, the advanced scan functions can be changed.

(Fig. 1)

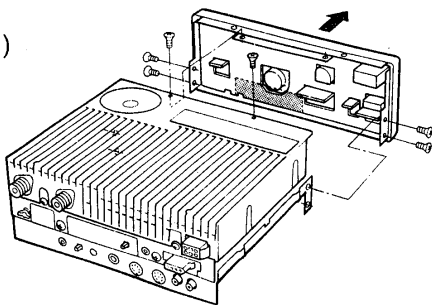

(Fig. 2)

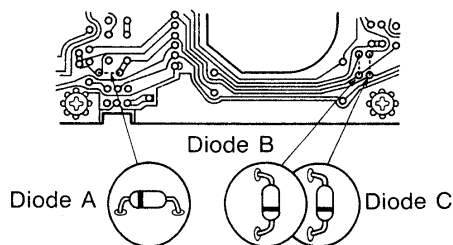

DIODE	DEFAULT	AFTER MODIFICATION
A	Faster scan speed with mic [UP]/[DN].	Slower scan speed with mic [UP]/[DN].
B	Scan resume.	Scan cancel.
C	Faster scan speed.	Slower scan speed.

- 1) Remove the top and bottom covers.
- 2) Unscrew the 6 screws and remove the front panel from the transceiver body as shown in figure 1.
- 3) Diode leads should be bent and cut before inserting them into the P.C. board.
- 4) Solder required diodes on the back of the P.C. board as shown in figure 2. Make sure they are inserted in the proper direction in the desired position.
- 5) Replace the front panel, top and bottom covers.

■ BFO adjustment

The BFO adjustment requires an accurate frequency counter (less than ± 1 ppm).

Connect the frequency counter to R266 on the main unit. See p. 45 or 47 for the exact location.

Make the adjustments shown in the diagram at right in numerical order.

	MODE	FREQUENCY	ADJUSTMENT
1	USB	9.01300 MHz	C294
2	CW transmit	9.01060 MHz	L83
3	LSB	9.01000 MHz	L82
4	CW receive	9.00980 MHz	Verify
5	AM	No oscillation	—

■ RIT adjustment

When the RIT control center position (RIT = ±0) is shifted, it can be adjusted by the internal variable resistance.

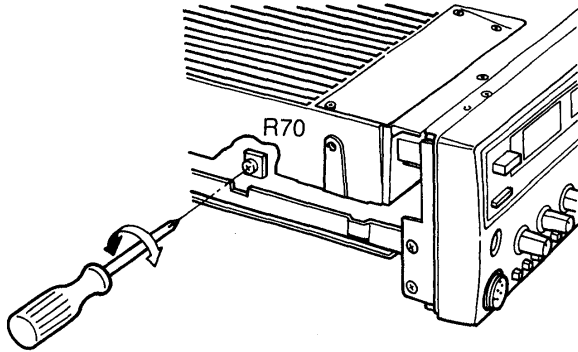

- 1) Remove the top cover and turn power ON.
- 2) Set the [RIT] control to the center position and turn OFF the RIT function if it is turned ON.
- 3) Receive a standard frequency station such as WWV.
- 4) Push the [RIT] switch to turn the RIT function ON. Adjust R70 on the PLL unit, as shown in the figure at left, to the same tone pitch as that received.
- 5) Turn the RIT function OFF and ON with the [RIT] switch to compare the two tone pitches and adjust R70 until both tone pitches are the same.
- 6) Replace the top cover.

■ HF bands PA idling current

The PA unit operates with a linear amplifier and requires some idling current to flow through the driver and final transistors to obtain bias voltage.

PA UNIT

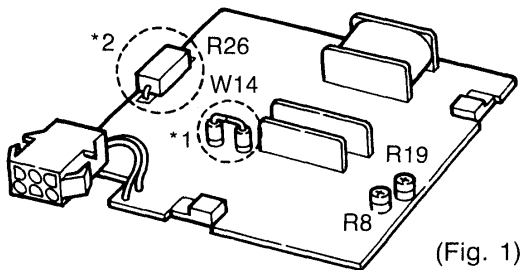

(Fig. 1)

DRIVER TRANSISTORS IDLING CURRENT

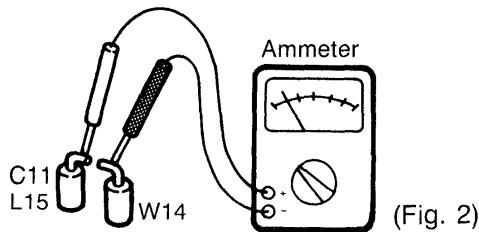

(Fig. 2)

FINAL TRANSISTORS IDLING CURRENT

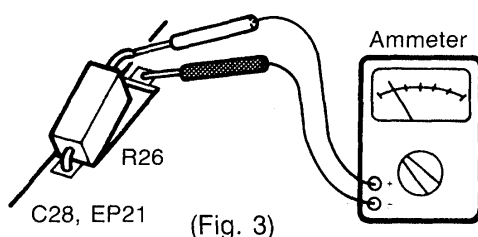

(Fig. 3)

- 1) Preparation:
 [POWER] : OFF
 [MIC GAIN] : Max. counterclockwise
 [RF PWR] : Max. counterclockwise
 Microphone : Disconnect
 Ammeter : 500 mA range
- 2) Remove the covers and open the PA unit following the disassembly procedures on pgs. 35 ~ 36.
- 3) Unsolder points indicated by *1 and *2.
- 4) Properly connect test leads to these points. See figure 2 for the driver amplifier and figure 3 for the final amplifier adjustments.
- 5) Turn transceiver power ON.
- 6) Push [SSB] to select LSB or USB.
- 7) Push [TRANSMIT] IN to transmit.
- 8) - Adjust R8 to set 100 mA for the driver amplifier.
 - Adjust R19 to set 300 mA for the final amplifier.
- 9) Turn transceiver power OFF.
- 10) Re-solder the de-solder points.
- 11) Reassemble the transceiver.

■ UI-7 AM•FM unit (For the IC-728)

This unit provides AM transmitting and FM transmitting/receiving capabilities for the IC-728.

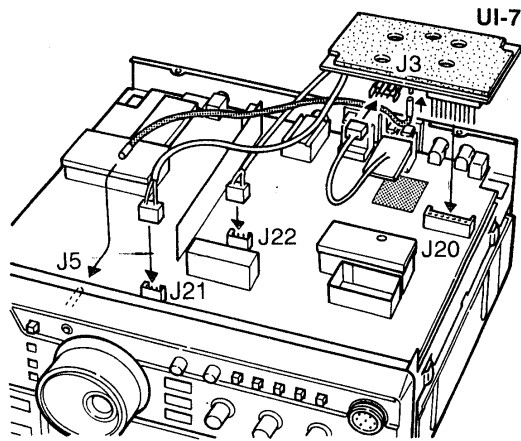

- 1) Remove the bottom cover.
- 2) Properly insert the 10-pin plug on the UI-7 to J20 on the main unit.
- 3) Connect the two 3-pin plugs from the UI-7 to J21 and J22 on the main unit respectively.
- 4) Connect the supplied brown wire between J5 on the front unit and J3 on the UI-7.
- 5) Form a wire harness using the supplied wire tie.
- 6) Replace the cover.

■ UT-30 programmable tone encoder unit

The UT-30 has 38 programmable tones available.

Jumper cable
(supplied with the IC-729
or the UI-7.)

UI-7 (The IC-729 already
includes this unit.)

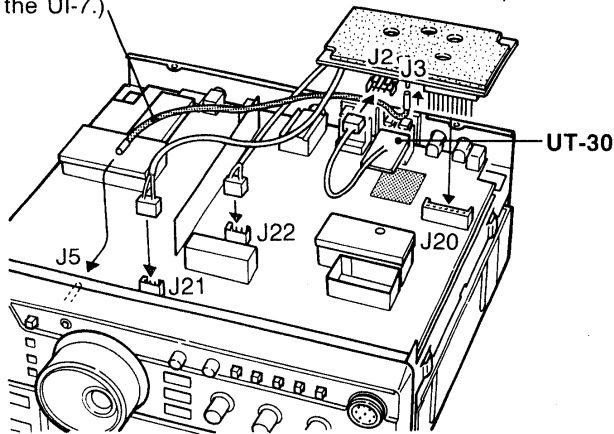

- 1) Remove the bottom cover.
- 2) Remove the UI-7 from the main unit.
- 3) Remove the protective paper from the back of the UT-30 to expose the adhesive strip.
- 4) Attach the UT-30 in the location marked on the main unit.
- 5) Connect all wires and cables as shown in the figure at left.
- 6) Install the UI-7 on the main unit again. See the above box for the unit installation.
- 7) Replace the cover.

■ MB-23 carrying handle

The carrying handle facilitates carrying and transporting of the transceiver.

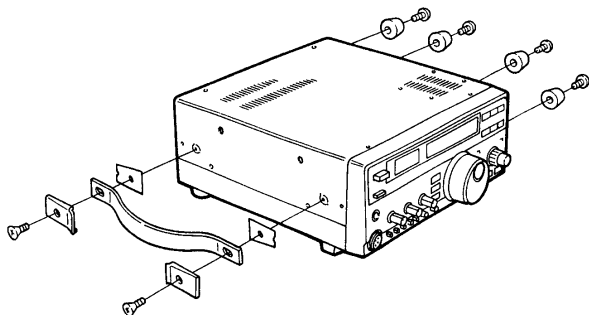

Attach the MB-23 as shown in the figure at left.

NOTE: Supplied screws with the MB-23 CANNOT be used with the IC-728/729. Please use the screws supplied with the IC-728/729 to correctly attach the MB-23.

■ FL-100 or FL-101 CW narrow filter

The FL-100 and FL-101 CW narrow filters provide CW-Narrow mode reception.

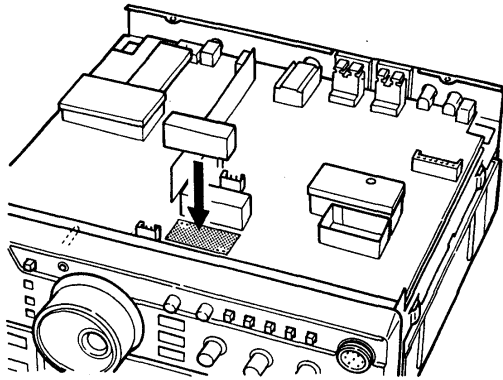

- 1) Remove the bottom cover.
- 2) Insert the filter at the proper position. The location is shown in the figure at left.
 - The filter works regardless of which direction it is inserted in.
- 3) Replace the cover.

FL-100	500 Hz/ - 6 dB
FL-101	250 Hz/ - 6 dB

■ CR-64 high-stability crystal unit

By replacing the original crystal unit with this unit, the total frequency stability of the transceiver will be improved.

CR-64 frequency stability: ± 0.5 ppm
 (-30°C ~ +60°C;
 -22°F ~ +140°F)

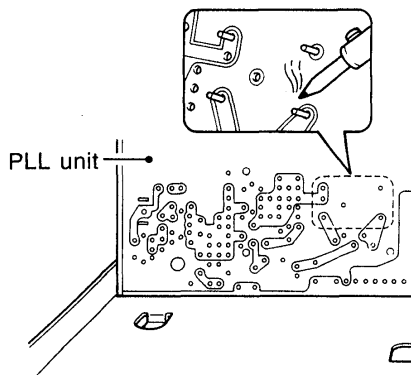
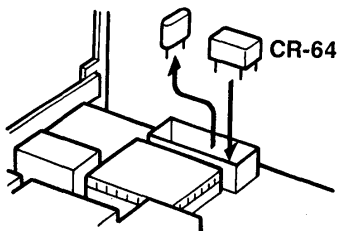
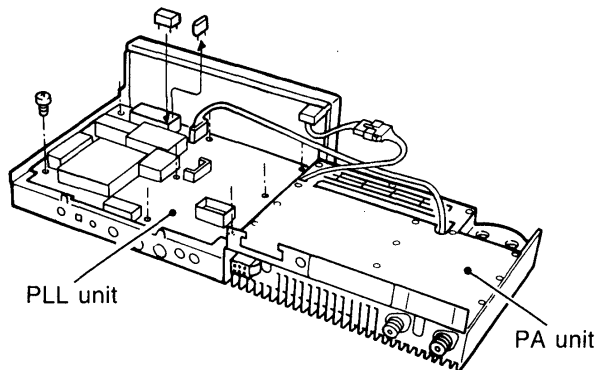

- 1) Remove the covers and the PLL unit following the disassembly procedures on pgs. 35 ~ 36.
- 2) Remove the regular crystal from the PLL unit.
- 3) Unsolder the 4 positions on the PLL unit where the CR-64 will be installed.
 - Use a de-soldering braid.
- 4) Install the CR-64 in the PLL unit, paying attention to orientation.
 - Symbols on the bottom of the CR-64 must be identically matched with symbols on the P.C. board.
- 5) Bend the leads of the CR-64 at the foil side of the P.C. board and solder them.
- 6) Trim the leads even with the solder points.
- 7) Replace the PLL unit and covers.

After changing the crystal unit, frequency adjustment is necessary with C134 on the PLL unit.

• Ask your Icom Dealer or Icom Service Center for details.

The CR-64 is an oven-heat-type crystal unit, and the specified frequency stability described above is guaranteed 1 min. after power ON.

■ Troubleshooting

The following chart is designed to help you correct problems which are not equipment malfunctions.

If you are not able to locate the cause of a problem or solve it through the use of this chart, contact your nearest Icom Dealer or Service Center.

	PROBLEM	POSSIBLE CAUSE	SOLUTION	REF.
POWER SUPPLY	Power does not come on when the [POWER] switch is pushed IN.	• DC power cable is improperly connected.	• Reconnect the power cable correctly.	p. 6
		• Fuse is blown.	• Check for the cause, then replace the fuse with a spare one. (Fuses are installed in two places. One is installed in the DC power cable and the other is installed in the PA unit.)	p. 37
		• Battery is exhausted (if you are using a 12 V battery as a power source).	• Check the battery voltage with the [POWER] switch pushed IN.	—
RECEIVE	No sound comes from the speaker.	• Volume level is too low.	• Rotate [AF GAIN] clockwise to obtain a suitable listening level.	p. 2
		• The squelch is closed.	• Rotate [SQUELCH] counterclockwise to open the squelch.	p. 2
		• The transceiver is in the transmitting condition.	• Push [TRANSMIT] OUT or check the SEND line of the external unit, if connected.	p. 1
		• An external speaker or headphones are connected.	• Check the external speaker or headphone plug connection.	pgs. 1, 5
		• CW-Narrow mode is selected without an optional CW filter.	• Check the speaker ON/OFF switch or speaker A/B switch, when an optional SP-20 EXTERNAL SPEAKER is in use.	—
		• FM mode is selected without an optional UI-7 AM-FM UNIT in the IC-728.	• Receiving in CW-Narrow mode requires an optional FL-100 or FL-101 CW narrow filter.	p. 42
		• Receiving in FM mode requires an optional UI-7 AM-FM UNIT for the IC-728.	• Receiving in FM mode requires an optional UI-7 AM-FM UNIT for the IC-728.	p. 41
Sensitivity is low.	• The antenna is not connected properly.	• Reconnect the antenna connector.	p. 10	
	• The antenna feedline is cut or shorted.	• Check the feedline and correct any improper conditions.	—	
	• The antenna for another band is connected.	• Connect an antenna suitable for the operating frequency.	—	
	• The antenna is not properly tuned when using an optional AH-3.	• Push [TUNE] to retune the antenna.	p. 27	
	• The attenuator function is activated.	• Push [ATT] OUT.	p. 1	
Receive audio is distorted.	• The operating mode is not selected correctly.	• Select a suitable operating mode.	p. 2	
	• PBT function is activated.	• Set [PBT] to the center position.	p. 25	
Receive signal is distorted with strong signals.	• Noise blanker function is activated.	• Push [NB] OUT.	p. 1	
	• Preamp is activated.	• Push [PREAMP] OUT.	p. 1	

	PROBLEM	POSSIBLE CAUSE	SOLUTION	REF
TRANSMIT	Transmitting is impossible.	<ul style="list-style-type: none"> • AM or FM mode is selected without an optional UI-7 AM-FM UNIT in the IC-728. • The operating frequency is not set to a ham band. 	<ul style="list-style-type: none"> • Transmitting in AM and FM modes requires an optional UI-7 AM-FM UNIT for the IC-728. • Set the frequency to a ham band. 	<p>p. 41</p> <p>p. 19</p>
	Output power is too low.	<ul style="list-style-type: none"> • [RF PWR] is set too far counter-clockwise. • [MIC GAIN] is set too far counter-clockwise. • The antenna is not connected properly. • The antenna feedline is cut or shorted. • An antenna for another band is connected. • The antenna is not properly tuned when using an optional AH-3. 	<ul style="list-style-type: none"> • Rotate [RF PWR] clockwise. • Set [MIC GAIN] to a suitable position. • Reconnect the antenna connector. • Check the feedline and correct any improper conditions. • Connect an antenna suitable for the operating frequency. • Push [TUNE] to retune the antenna. 	<p>p. 2</p> <p>pgs. 2, 23</p> <p>p. 10</p> <p>—</p> <p>—</p> <p>p. 27</p>
	No contact possible with another station.	<ul style="list-style-type: none"> • RIT function is activated. • Split function is activated. 	<ul style="list-style-type: none"> • Push [RIT] to turn the function OFF. • Push [SPLIT] to turn the function OFF. 	<p>p. 25</p> <p>p. 26</p>
	Repeater cannot be accessed.	<ul style="list-style-type: none"> • Split function is not activated. • An incorrect transmit frequency is set. • Subaudible tone encoder has been turned OFF to access a repeater which requires a tone for access. 	<ul style="list-style-type: none"> • Push [SPLIT] to turn the function ON. • Set the proper frequencies into VFO A and B or into memory channel 23 or 24. • Push [LOCK] IN. (An optional UT-30 is necessary to generate the subaudible tone.) 	<p>p. 26</p> <p>pgs. 26, 32</p> <p>p. 41</p>
	Transmitted signals are distorted.	<ul style="list-style-type: none"> • [MIC GAIN] is rotated too far clockwise. • [LEVEL] is rotated too far clockwise with the speech compressor ON. 	<ul style="list-style-type: none"> • Set [MIC GAIN] to a suitable position. • Set [LEVEL] to a suitable position. 	<p>pgs. 2, 23</p> <p>p. 2</p>
DISPLAY	The displayed frequency does not change properly.	<ul style="list-style-type: none"> • The dial lock function is activated. • The internal CPU has malfunctioned. 	<ul style="list-style-type: none"> • Push [LOCK] OUT. • Perform CPU resetting. (While pushing and holding [FUNC] and [MW], turn power ON.) 	<p>p. 3</p> <p>p. 37</p>
	Frequency changes while transmitting	<ul style="list-style-type: none"> • Split function is activated. 	<ul style="list-style-type: none"> • Push [SPLIT] to turn the function OFF. 	<p>p. 26</p>
SCAN	Scan does not stop.	<ul style="list-style-type: none"> • Squelch is open. 	<ul style="list-style-type: none"> • Set [SQUELCH] to the threshold point. 	<p>p. 2</p>
	Programmed scan does not start.	<ul style="list-style-type: none"> • The same frequencies have been programmed in memory channels 25 and 26. • Scan edge frequencies have been programmed beyond the receive frequency range of the IC-729. 	<ul style="list-style-type: none"> • Program different frequencies into memory channels 25 and 26. • Program frequencies in the same range, 0.03~33 MHz or 46.2~61.1 MHz, into memory channels 25 and 26 in the IC-729. 	<p>p. 33</p> <p>p. 33</p>
	Selected mode memory scan does not start.	<ul style="list-style-type: none"> • 2 or more memory channels containing the selected mode have not been programmed. 	<ul style="list-style-type: none"> • Program 2 or more memory channels with the same operating mode for the scan. 	<p>p. 33</p>

■ IC-728 main unit

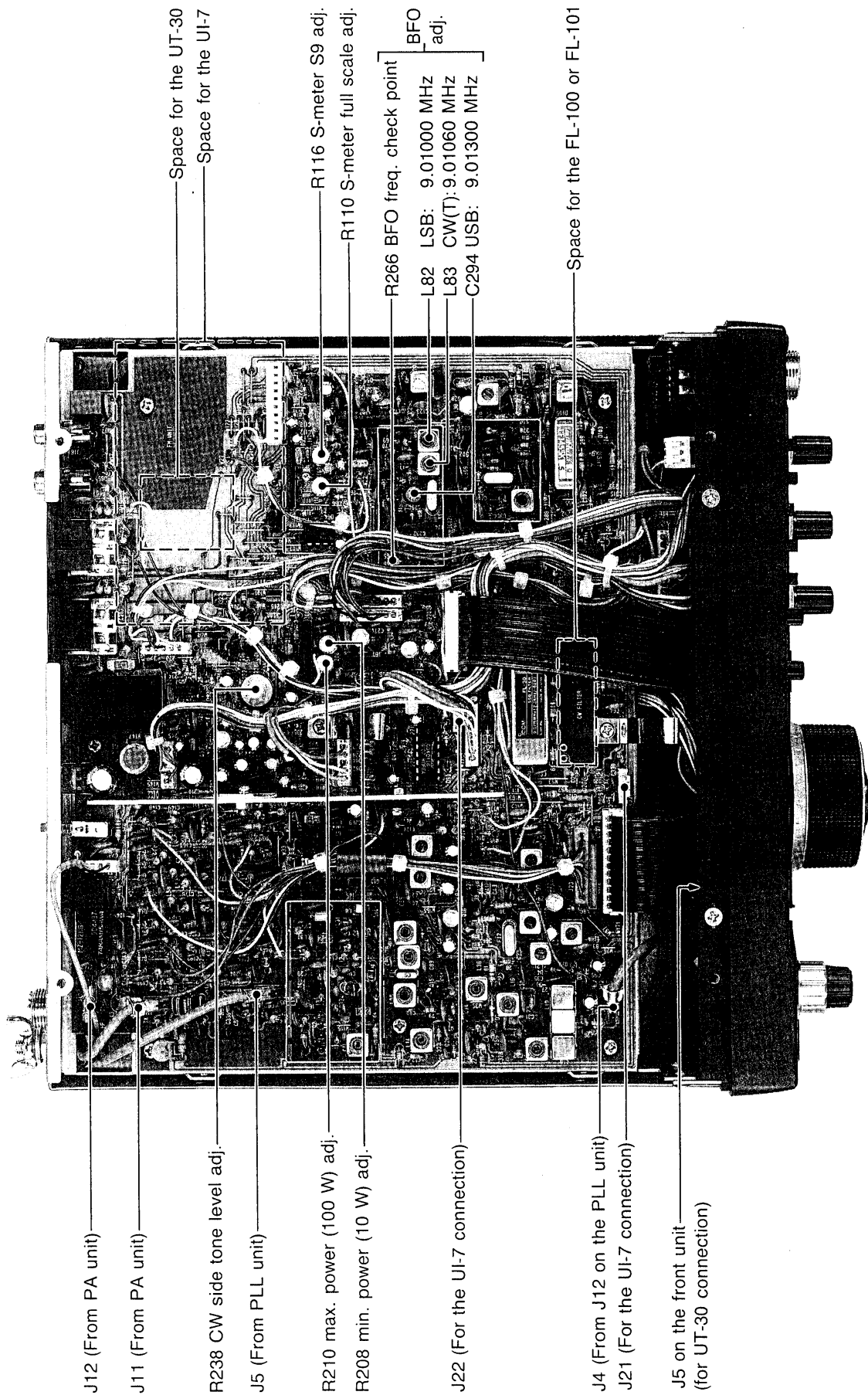

J12 (From PA unit)

J11 (From PA unit)

R238 CW side tone level adj.

J5 (From PLL unit)

R210 max. power (100 W) adj.

R208 min. power (10 W) adj.

J22 (For the UI-7 connection)

J4 (From J12 on the PLL unit)

J21 (For the UI-7 connection)

J5 on the front unit
(for UT-30 connection)

Space for the UT-30

Space for the UI-7

R116 S-meter S9 adj.

R110 S-meter full scale adj.

R266 BFO freq. check point
BFO adj.
L82 LSB: 9.01000 MHz
L83 CW(T): 9.01060 MHz
C294 USB: 9.01300 MHz

Space for the FL-100 or FL-101

■ IC-728 PLL unit

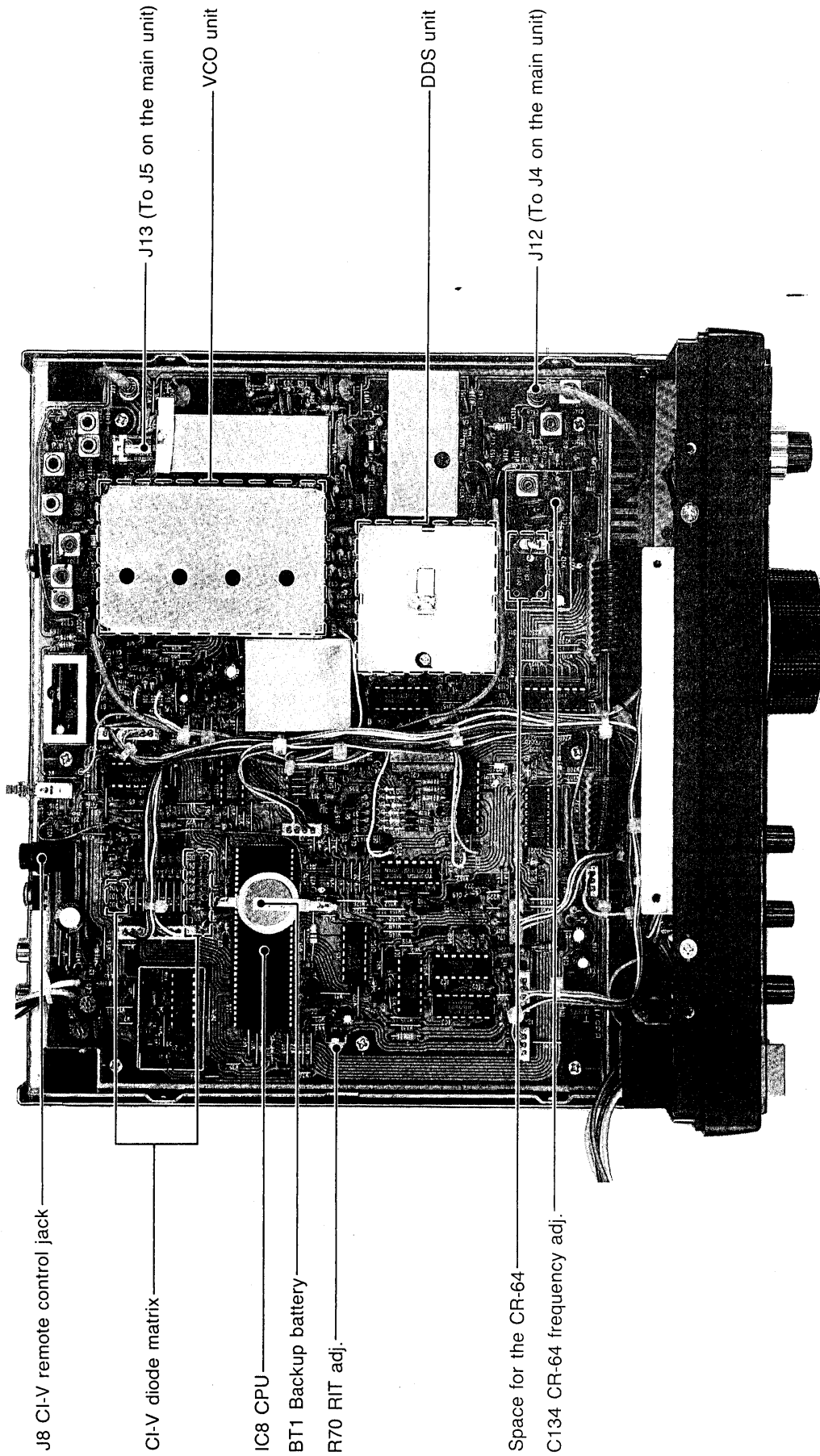

J8 CI-V remote control jack

CI-V diode matrix

IC8 CPU

BT1 Backup battery

R70 RIT adj.

Space for the CR-64

C134 CR-64 frequency adj.

J12 (To J4 on the main unit)

DDS unit

VCO unit

J13 (To J5 on the main unit)

■ IC-729 main unit

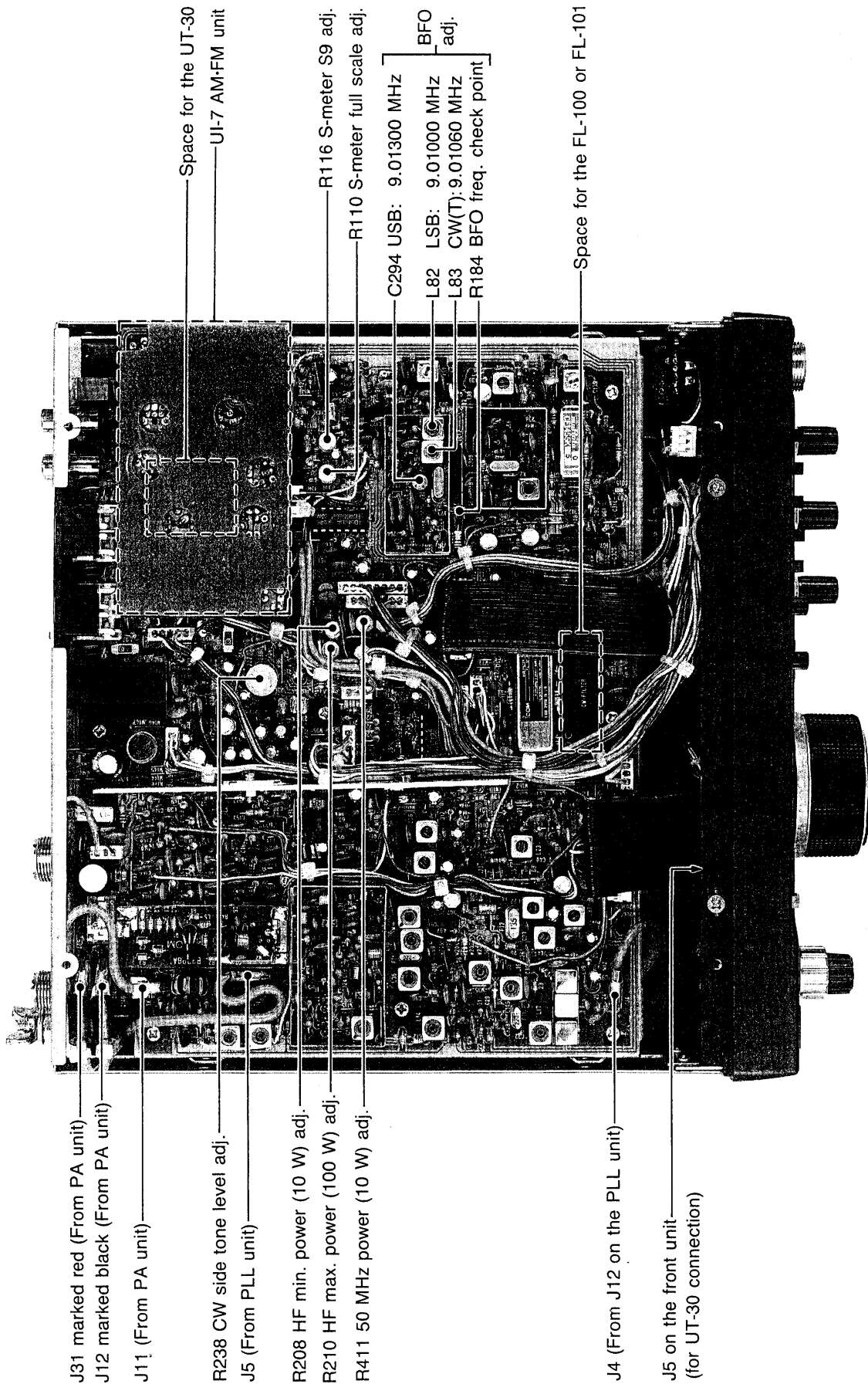

J31 marked red (From PA unit)

J12 marked black (From PA unit)

J11 (From PA unit)

R238 CW side tone level adj.

J5 (From PLL unit)

R208 HF min. power (10 W) adj.

R210 HF max. power (100 W) adj.

R411 50 MHz power (10 W) adj.

Space for the UT-30

UI-7 AM-FM unit

R116 S-meter S9 adj.

R110 S-meter full scale adj.

C294 USB: 9.01300 MHz

L82 LSB: 9.01000 MHz

L83 CW(T): 9.01060 MHz

R184 BFO freq. check point

BFO adj.

Space for the FL-100 or FL-101

J4 (From J12 on the PLL unit)

J5 on the front unit
(for UT-30 connection)

Downloaded by
RadioAmateur.EU

■ IC-729 PLL unit

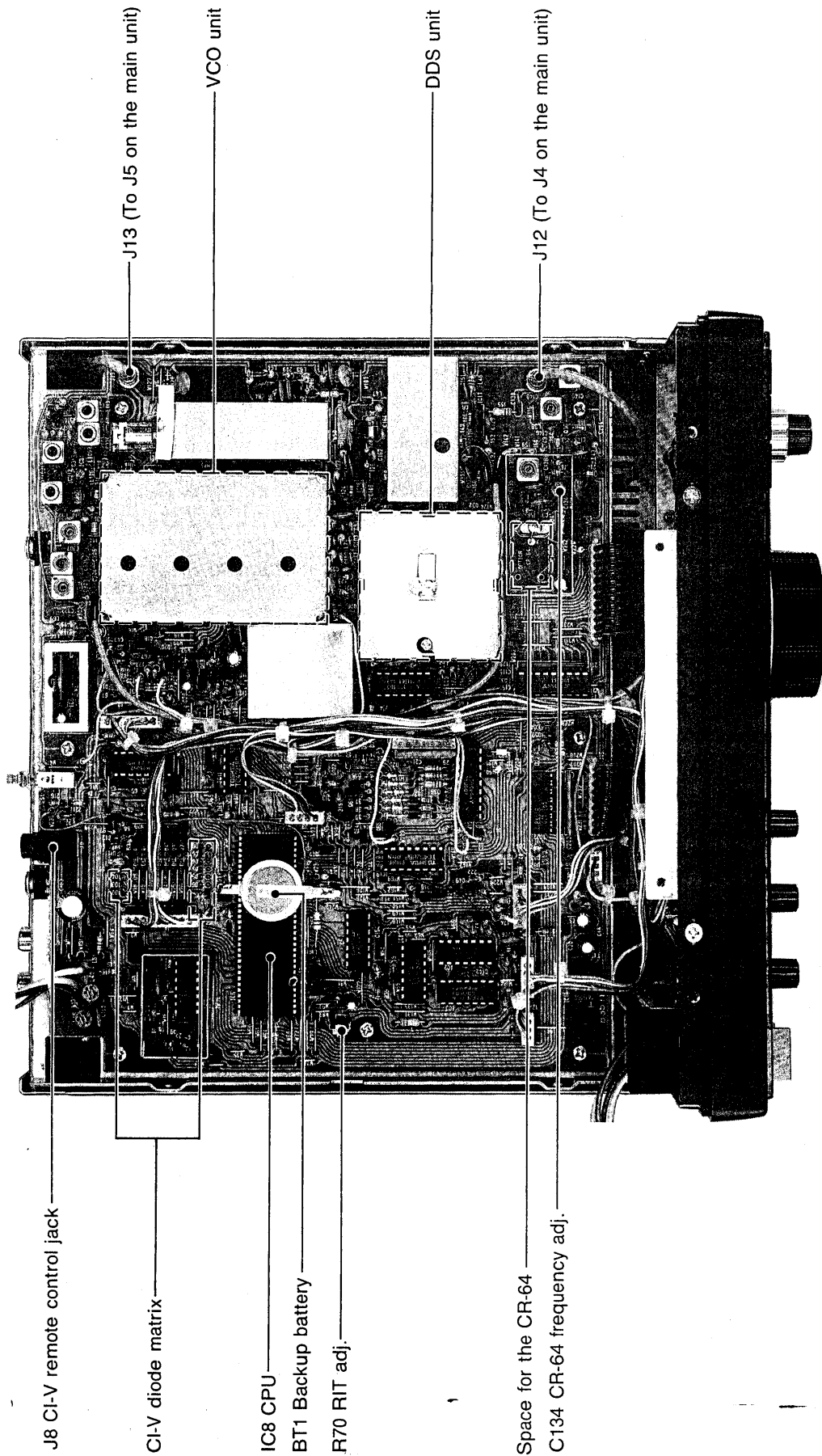

10 SPECIFICATIONS

■ GENERAL

- Frequency coverage: Receive
 - 500 kHz ~ 30 MHz
 - 50 MHz ~ 54 MHz (IC-729 only)
 Transmit
 - 1.800 ~ 1.99999 MHz
 - 3.500 ~ 4.000 MHz
 - 7.000 ~ 7.300 MHz
 - 10.100 ~ 10.150 MHz
 - 14.000 ~ 14.350 MHz
 - 18.068 ~ 18.168 MHz
 - 21.000 ~ 21.450 MHz
 - 24.890 ~ 24.990 MHz
 - 28.000 ~ 29.700 MHz
 - 50.000 ~ 54.000 MHz (IC-729 only)

- Mode : SSB, CW, AM*, FM*
 - * An optional UI-7 is required for the IC-728.

- Number of memory : 26 channels

- Antenna impedance : 50 Ω nominal

- Usable temperature : -10°C ~ +60°C; range +14°F ~ +140°F

- Frequency stability : Less than ±200 Hz from 1 min. to 60 min. after power ON. After that the rate of stability change is less than ±30 Hz/hr. at +25°C; +77°F. Temperature fluctuations (0°C ~ +50°C; +32°F ~ +122°F) less than ±350 Hz.

- Power supply requirement : 13.8 V DC ±15%

- Current drain : Transmit 20 A
 Receive squelched 1.3 A
 max. audio output 1.6 A

- Dimensions : 241(W) × 94(H) × 239(D) mm
 9.5(W) × 3.7(H) × 9.4(D) in
 (projections not included)

- Weight : IC-728 4.6 kg; 10.1 lb
 IC-729 4.9 kg; 10.8 lb

■ TRANSMITTER

- Output power :

1.8 ~ 30 MHz	SSB, CW, FM	100 W
	AM	40 W
50 ~ 54 MHz (IC-729 only)	SSB, CW, FM	10 W
	AM	4 W

- Spurious emissions :

1.8 ~ 30 MHz	Less than -50 dB
--------------	------------------

- | | |
|------------------------------|------------------|
| 50 ~ 54 MHz
(IC-729 only) | Less than -60 dB |
|------------------------------|------------------|

- Carrier suppression : More than 40 dB

- Unwanted sideband : More than 50 dB

- Microphone impedance : 600 Ω

■ RECEIVER

- Receive system : SSB, CW, AM, FM*
 - Triple-conversion superheterodyne
 - * An optional UI-7 is required for the IC-728.

- Intermediate frequencies:

MODE	1st	2nd	3rd
SSB	70.4515 MHz	9.0115 MHz	455 kHz
CW	70.4506 MHz	9.0106 MHz	455 kHz
AM, FM	70.4500 MHz	9.0100 MHz	455 kHz

- Sensitivity (Preamp ON):

0.5 ~ 1.8 MHz	AM	Less than 13.0 μV for 10 dB S/N
---------------	----	---------------------------------

- | | | |
|--------------|------------------|----------------------------------|
| 1.8 ~ 30 MHz | SSB, CW | Less than 0.16 μV for 10 dB S/N |
| | AM | Less than 2.0 μV for 10 dB S/N |
| | FM (28 ~ 30 MHz) | Less than 0.5 μV for 12 dB SINAD |

- | | | |
|------------------------------|---------|----------------------------------|
| 50 ~ 54 MHz
(IC-729 only) | SSB, CW | Less than 0.13 μV for 10 dB S/N |
| | AM | Less than 2.0 μV for 10 dB S/N |
| | FM | Less than 0.3 μV for 12 dB SINAD |

- Selectivity : SSB, CW

More than 2.1 kHz/ -6 dB
Less than 4.0 kHz/ -60 dB
AM
More than 6.0 kHz/ -6 dB
Less than 20.0 kHz/ -40 dB
FM
More than 12 kHz/ -6 dB
Less than 30 kHz/ -50 dB

- Spurious and image rejection ratio : More than 70 dB

- Audio output power : More than 2.6 W with an 8 Ω load

- RIT variable range : ±1.2 kHz

All stated specifications are subject to change without notice or obligation.

IC-4KL HF 1 kW LINEAR AMPLIFIER

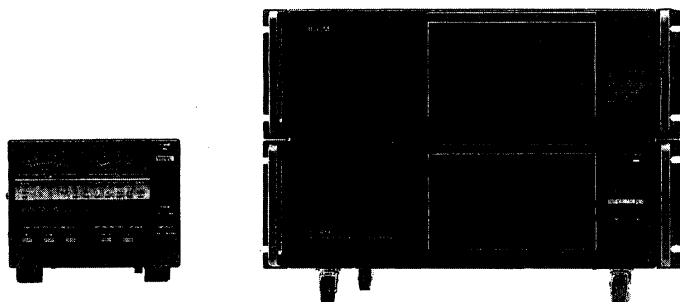

This is an all solid-state full-duty 1 kW linear amplifier. The IC-4KL is fully controlled from the IC-728/729. No need to tune and no need to switch the operating band. Full break-in operation is possible.

The amplifier/power supply unit and the remote control unit are separated. Place the amplifier/power supply unit under your operating desk.

IC-2KL HF 500 W LINEAR AMPLIFIER

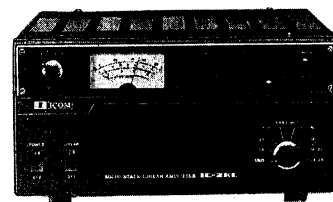

This is an all solid-state 500 W linear amplifier. The power amplifier unit can be separately set-up from the power supply unit.

IC-AT500 HF AUTOMATIC ANTENNA TUNER



500 W automatic antenna tuner, best match for the IC-728/729 with the IC-2KL. Including an automatic antenna selector for 4 separate antennas.

AT-160 HF AUTOMATIC ANTENNA TUNER

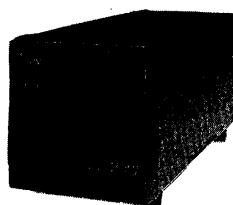

Can be attached to the IC-728/729 side panel. Power and tuning operation is controlled through the IC-728/729.

AT-150 HF AUTOMATIC ANTENNA TUNER

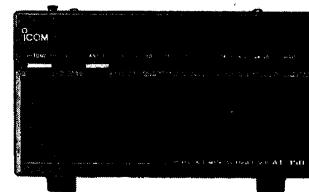

Style and size are matched with the IC-728/729. Including an automatic antenna selector for 3 separate antennas, moreover, a long wire antenna can be tuned.

AH-3 HF AUTOMATIC ANTENNA TUNER

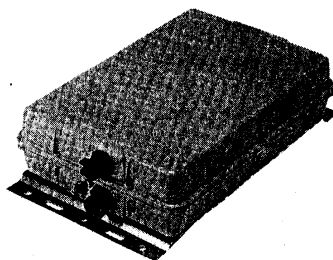

Matches the IC-728/729 to a long wire antenna for portable or mobile operation.
• Input power rating : 150 W

AH-2b ANTENNA ELEMENT



A 2.5 m long antenna element for mobile operation with the AH-3.

EX-627 AUTOMATIC ANTENNA SELECTOR

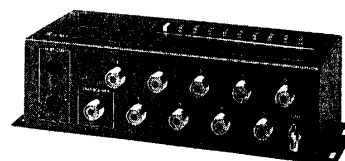

Automatically selects the antenna for the selected ham band. Manual selection is also possible.
• Max. input power : 1000 W PEP

11 OPTIONS

IC-PS15 DC POWER SUPPLY



Heavy-duty power transformer system power supply. Power ON/OFF is relayed to the transceiver power switch.

- Output voltage : 13.8 V DC
- Max. current drain: 20 A

IC-PS30 DC POWER SUPPLY

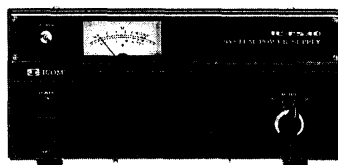

A lightweight switching regulator system power supply equipped with 3 extra output connectors.

- Output voltage : 13.8 V DC
- Max. current drain: 25 A

PS-55 DC POWER SUPPLY

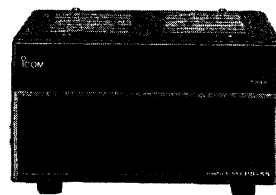

A heavy-duty power transformer system power supply. Built-in cooling fan for full-duty operation. The size is matched with the IC-728/729.

- Output voltage : 13.8 V DC
- Max. current drain: 20 A

IC-SP3 EXTERNAL SPEAKER

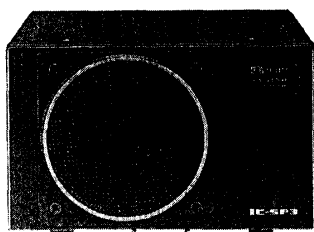

External speaker designed for base station operation.

- Input impedance : 8 Ω
- Max. input power : 4 W

SP-7 EXTERNAL SPEAKER

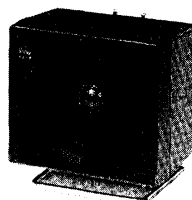

Designed for base station operation. Style and size are matched with the IC-728/729.

- Input impedance : 8 Ω
- Max. input power : 5 W

SP-20 EXTERNAL SPEAKER

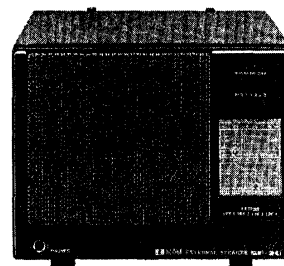

Designed for base station operation. Equipped with 4 types of audio filters, a headphone jack and can be connected to 2 transceivers.

- Input impedance : 8 Ω
- Max. input power : 5 W

SM-6 DESKTOP MICROPHONE

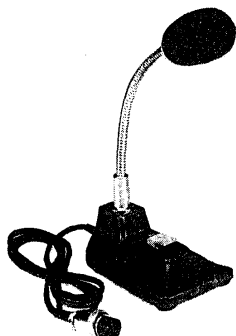

Electret condenser-type desktop microphone for base station operation.

SM-8 DESKTOP MICROPHONE

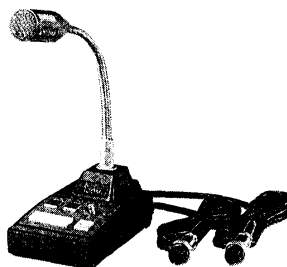

Electret condenser-type desktop microphone including 2 connection cables for simultaneous connection of 2 transceivers. [UP]/[DOWN] switches also come with the microphone.

SM-20 DESKTOP MICROPHONE



Unidirectional, electret microphone for base station operation.

Includes [UP]/[DOWN] switches and a low audio cut function.

CT-16 SATELLITE INTERFACE UNIT

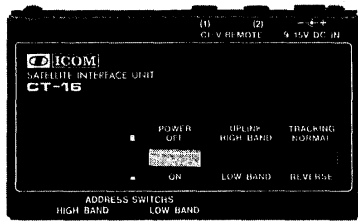

Easy tuning for instant satellite communications.

CT-17 CI-V LEVEL CONVERTER

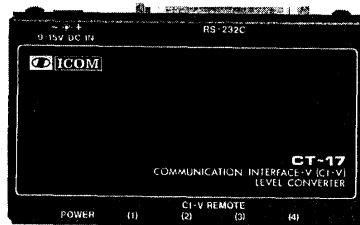

For remote transceiver control using a personal computer equipped with an RS-232C output port. You can change frequencies, operating mode, memory channels, etc., via your computer keyboard.

CR-64 HIGH-STABILITY CRYSTAL UNIT

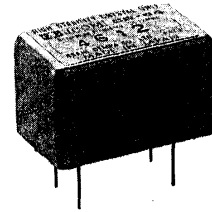

Contains a temperature-compensating oven heater and crystal unit for improved frequency stability.

- Frequency stability : 0.5 ppm (-30°C ~ +60°C; -22°F ~ +140°F)

FL-100/FL-101 CW NARROW FILTERS

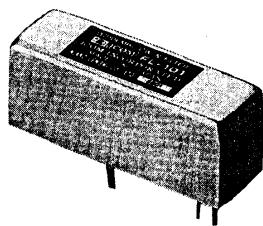

Have good shape factors and provide you with better CW reception during crowded band conditions.

- Passband width:
- FL-100 : 500 Hz / -6 dB
 - FL-101 : 250 Hz / -6 dB

UI-7 AM-FM UNIT

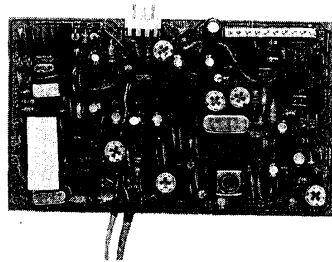

Provides AM transmitting and FM transmitting/receiving for the IC-728.

UT-30 PROGRAMMABLE TONE ENCODER UNIT

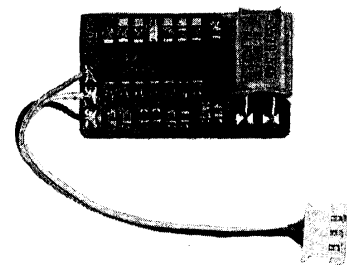

Provides 38 programmable subaudible tones.

IC-MB5 MOBILE MOUNTING BRACKET

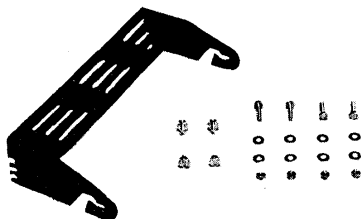

Transceiver bracket for mobile operation.

MB-23 CARRYING HANDLE

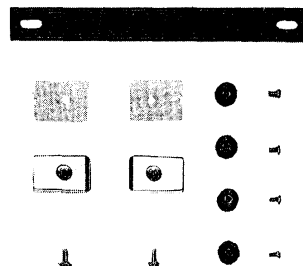

Carrying handle for easy portable operation.

For MB-23 use, some screws are supplied with the transceiver.

HM-12 HAND MICROPHONE

Same type as supplied with the IC-728/729.

OPC-025A DC POWER CABLE

Same type as supplied with the IC-728/729.

Downloaded by
RadioAmateur.EU

Count on us!

